

Spe

SONY®

3-861-229-13(1)

# **Mini Hi-Fi Component System**

---

Operating Instructions

## Owner's Record

The model and serial numbers are located on the rear panel of the unit. Record the serial number in the space provided below. Refer to them whenever you call upon your Sony dealer regarding this product.

Model No. \_\_\_\_\_ Serial No. \_\_\_\_\_



**DHC-MD515**

## WARNING

To prevent fire or shock hazard, do not expose the unit to rain or moisture.

To avoid electrical shock, do not open the cabinet. Refer servicing to qualified personnel only.

Do not install the appliance in a confined space, such as a bookcase or built-in cabinet.

US and foreign patents licensed from Dolby Laboratories Licensing Corporation.

The laser component in this product is capable of emitting radiation exceeding the limit for Class 1.

CLASS 1 LASER PRODUCT  
LUOKAN 1 LASERLÄITIN  
KLASS 1 LASERAPPARAT

This appliance is classified as a CLASS 1 LASER product. The CLASS 1 LASER PRODUCT MARKING is located on the rear exterior.

This caution label is located inside the unit.

CAUTION: AVOID LASER RADIATION WHEN OPEN AND INTERIOR ILLUMINATED. AVOID EXPOSURE TO BEAM.  
ADVARSEL: UNNSIK LASERSTRÅLING VED ÅBNING NÅR BELYSNINGSANLEGGENE ER I GÅENDE. UNNSIK UDSÆTTELSE FOR STRÅLING.  
VORSICHT: UNTERSCHIEDLICHE LASERSTRÄHLUNG, WENN ABDECKUNG GEÖFFNET UND BUCHENREIFLICHENBELEUCHTUNG ÜBERBRÜCKT. NICHT DIE STRAHLE ANSEHEN!  
VAROITUS: ERÄTTÄMÄÄ LASERVALONIN OHTETTÄISSÄ OLET ALI TILIN VÄHÄLTYMÄÄLLÄ. HESITÄTÄVÄLLE, ÄLÄ KÄTTÖÖ SÄTEESÄÄN.  
VARNING: ÖPPNA LASERSTRÅLING NÄR DENNA EN I GÅENDE OCH STRÅLNINGEN ÄR ONSKÖPLIG. BEHÅNDLA EJ STRÅLNINGEN.  
ADVARSEL: ÖPPNINGS LASERSTRÅLING NÄR DENNEN I GÅENDE OG SKIKKESIKKESJAG BRITES. HÅNDL BEHÅNDLING FOR STRÅLINGEN.  
VIGYAZAT: A BUNYOLAT NYITÁSBOR LÁTHATLAN LÉZERSUGÁRRAZÁSRA VESZŐLEGES A VÉDELMEZÉS!

## NOTICE FOR THE CUSTOMERS IN THE U.S.A.



This symbol is intended to alert the user to the presence of uninsulated "dangerous voltage" within the product's enclosure that may be of sufficient magnitude to constitute a risk of electric shock to persons.

This symbol is intended to alert the user to the presence of important operating and maintenance (servicing) instructions in the literature accompanying the appliance.

## CAUTION

2 The use of optical instruments with this product will increase eye hazard.

## INFORMATION

This equipment has been tested and found to comply with the limits for a Class B digital device, pursuant to Part 15 of the FCC Rules. These limits are designed to provide reasonable protection against harmful interference in a residential installation. This equipment generates, uses, and can radiate radio frequency energy and, if not installed and used in accordance with the instructions, may cause harmful interference to radio communications. However, there is no guarantee that interference will not occur in a particular installation. If this equipment does cause harmful interference to radio or television reception, which can be determined by turning the equipment off and on, the user is encouraged to try to correct the interference by one or more of the following measures:

- Reorient or relocate the receiving antenna.
- Increase the separation between the equipment and receiver.
- Connect the equipment into an outlet on a circuit different from that to which the receiver is connected.
- Consult the dealer or an experienced radio/TV technician for help.

## CAUTION

You are cautioned that any changes or modifications not expressly approved in this manual could void your authority to operate this equipment.

## Note on CATV system installer:

This reminder is provided to call CATV system installer's attention to Article 820-40 of the NEC that provides guidelines for proper grounding and, in particular, specifies that the cable ground shall be connected to the grounding system of the building, as close to the point of cable entry as practical.

## NOTICE FOR THE CUSTOMERS IN CANADA

### CAUTION:

TO PREVENT ELECTRIC SHOCK, DO NOT USE THIS POLARIZED AC PLUG WITH AN EXTENSION CORD, RECEPTACLE OR OTHER OUTLET UNLESS THE BLADES CAN BE FULLY INSERTED TO PREVENT BLADE EXPOSURE.



## Table of Contents

### Getting Started

|   |    |
|---|----|
| Step 1: Hooking up the system .....                           | 4  |
| Step 2: Setting the time .....                                | 5  |
| Step 3: Presetting radio stations .....                       | 6  |
| Step 4: Using the detachable controller .....                 | 8  |
| Connecting optional A/V components and outdoor antennas ..... | 10 |

### Basic Operations

|                                     |    |
|-------------------------------------|----|
| Playing a CD .....                  | 12 |
| Recording a whole CD on an MD ..... | 13 |
| Playing an MD .....                 | 15 |
| Listening to the radio .....        | 17 |
| Recording from the radio .....      | 18 |

### The CD Player

|   |    |
|---|----|
| Playing CD tracks repeatedly .....      | 20 |
| Playing CD tracks in random order ..... | 20 |
| Programming CD tracks .....             | 21 |
| Using the CD display .....              | 23 |
| Looping part of a CD track .....        | 24 |
| Labeling a CD .....                     | 25 |
| Checking the CD-TEXT information ..     | 27 |

### The MD Deck - Playing

|   |    |
|---|----|
| Playing MD tracks repeatedly .....      | 29 |
| Playing MD tracks in random order ..... | 29 |
| Programming MD tracks .....             | 30 |
| Using the MD display .....              | 32 |

### The MD Deck - Recording

|   |    |
|---|----|
| Before you start recording .....                | 33 |
| Recording methods on this system .....          | 34 |
| Recording multiple CDs on multiple MDs .....    | 35 |
| Recording multiple CDs on MDs in sequence ..... | 36 |

|   |    |
|---|----|
| Recording your favorite CD tracks on MDs .....                  | 37 |
| Recording only the first track on each CD .....                 | 39 |
| Recording the current CD track .....                            | 40 |
| Recording on an MD manually .....                               | 41 |
| Starting recording with 6 seconds of prestored audio data ..... | 42 |
| Marking track numbers .....                                     | 43 |
| Making a space between tracks 3 seconds long .....              | 44 |

### The MD Deck - Editing

|                                 |    |
|---------------------------------|----|
| Before you start editing .....  | 45 |
| Labeling an MD .....            | 46 |
| Erasing recordings .....        | 47 |
| Moving recorded tracks .....    | 49 |
| Diving recorded tracks .....    | 50 |
| Combining recorded tracks ..... | 51 |
| Undoing the last edit .....     | 53 |

### Sound Adjustment

|  |    |
|--|----|
| Adjusting the sound .....              | 54 |
| Selecting the Preset Equalizer menu .. | 54 |

### Other Features

|                                      |    |
|--------------------------------------|----|
| Labeling the preset stations .....   | 55 |
| Using the Radio Data System (RDS) .. | 56 |
| Falling asleep to music .....        | 58 |
| Waking up to music .....             | 59 |
| Timer recording radio programs ..... | 60 |

### Additional Information

|   |    |
|---|----|
| Precautions .....                       | 63 |
| Using the Self-Diagnostic Display ..... | 64 |
| System limitations of MDs .....         | 65 |
| Troubleshooting .....                   | 65 |
| Specifications .....                    | 69 |
| Index .....                             | 71 |

## Getting Started

### Step 1: Hooking up the system

Follow steps **1** and **2** to hook up your system using the supplied cords and accessories. Follow steps **3** and **4** to complete the hook up procedure.

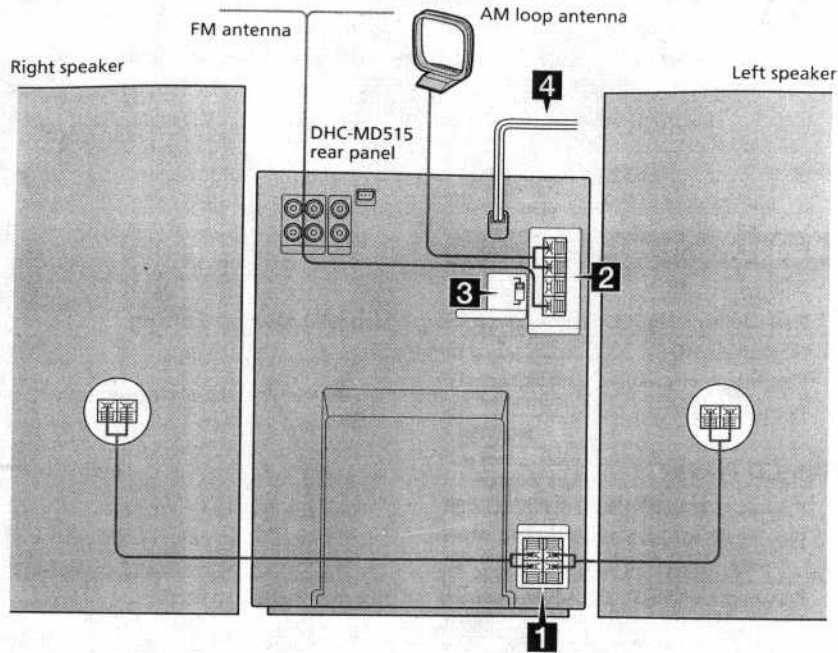

#### 1 Connect the speakers.

Connect the speaker cords to SPEAKER terminals of the same color. Keep the speaker cords away from the antennas to prevent noise.

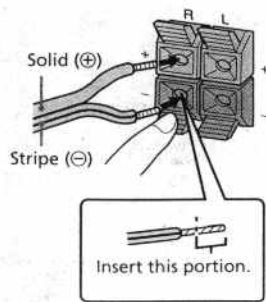

#### 2 Connect the FM/AM antennas.

Set up the AM loop antenna, then connect it.

##### European model

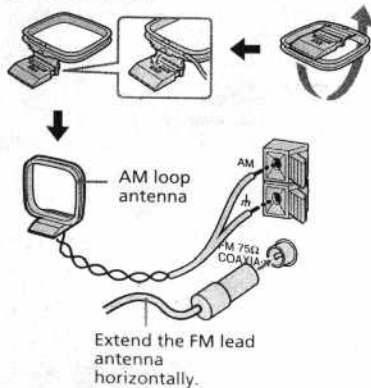

Extend the FM lead antenna horizontally.

#### Other models

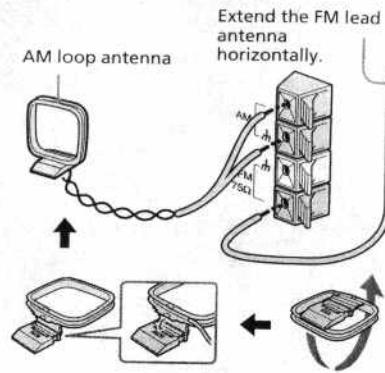

- 3** Set VOLTAGE SELECTOR to the position of your local power line voltage (except for North American and European model).

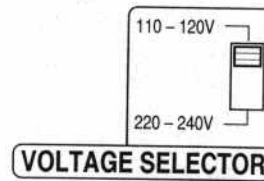

- 4** Connect the AC power cord to a wall outlet.

If the plug of the AC power cord does not fit your wall outlet, detach the supplied adapter from the plug (except for North American and European model).

#### Before you turn on the system

Remove the transport MD cartridge from the slot. If you turn on the system before removing the cartridge, "MD MECHA ERROR" appears. Turn off the system, then remove the cartridge after the clock display appears (see page 63).

### Step 2: Setting the time

You must set the time before you can use the timer functions. The clock is on a 24-hour system for the European model, and a 12-hour system for other models. The 12-hour system is used for illustration purpose. You can set the time while the power is off.

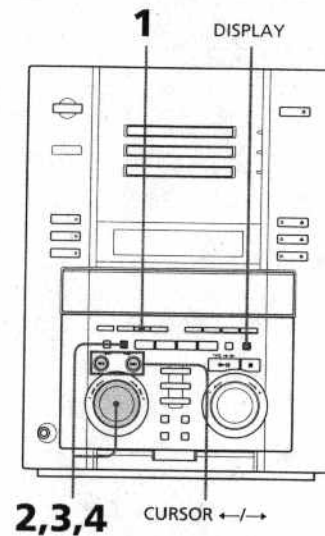

- 1** Press CLOCK/TIMER SET.

The day of the week indication ("SUN") flashes.



- 2** Turn MULTI JOG to set the day of the week, then press ENTER/YES. The hour indication flashes.

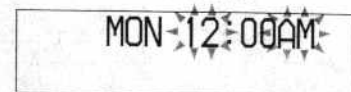

continued 5

## Step 2: Setting the time (continued)

- 3** Turn MULTI JOG to set the hour, then press ENTER/YES. The minute indication flashes.

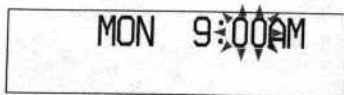

- 4** Turn MULTI JOG to set the minute, then press ENTER/YES. The clock starts.

### If you have made a mistake

Press CURSOR ← or → repeatedly so that the incorrect setting flashes, then set it again.

### To change the preset time

You can set the time or change the preset time while the power is on.

- 1 Press CLOCK/TIMER SET.
- 2 Turn MULTI JOG until "SET CLOCK?" appears.
- 3 Press ENTER/YES.
- 4 Repeat steps 2 through 4 above.

### To display the clock

The built-in clock shows the time in the display while the power is off. To display the time while the power is on, press DISPLAY.

Each time you press the button, the display changes as follows:

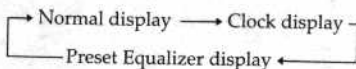

### Tip

The upper dot flashes for the first half of a minute (0 to 29 seconds), and the lower dot flashes for the last half of a minute (30 to 59 seconds).

## Step 3: Presetting radio stations

You can preset the following number of stations:

- North American model: 20 for FM and 10 for AM.
- European model: 20 for FM, 10 for MW and 10 for LW.
- Other models: 20 for FM, 10 for MW and 10 for SW.

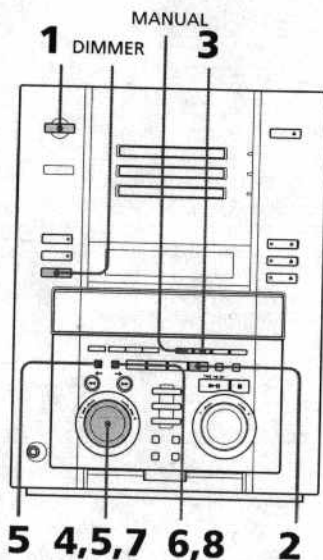

### Tuning in the desired radio station

- 1** Press POWER to turn on the system.

- 2** Press TUNER repeatedly until the band you want appears. Each time you press the button, the band changes as follows:

North American model:

FM → AM

European model:

FM → MW → LW

Other models:

FM → MW → SW

- 3** Press AUTO.

- 4** Turn MULTI JOG.

The frequency indication changes and scanning stops when the system tunes in a station. "TUNED" and "STEREO" (for a stereo program) appear. To stop tuning, press ■.

### Presetting the radio station

- 5** Press EDIT/NO, then turn MULTI JOG until "TUNER Memory?" appears.



- 6** Press ENTER/YES.

- 7** Turn MULTI JOG to select the desired preset number.



- 8** Press ENTER/YES. The station is stored.

- 9** Repeat steps 2 through 8 to preset other stations.

### To tune in a station with a weak signal

Press MANUAL in step 3, then turn MULTI JOG to tune in the station and continue from step 5.

### To change the preset number

Start over from step 2.

### To change the AM/MW tuning interval (except for European model)

The AM/MW tuning interval is factory-set to 9 kHz (10 kHz in some areas). To change the AM/MW tuning interval, tune in any AM/MW station first, then turn off the power. While holding down the DIMMER button, turn the power back on. When you change the interval, all the AM/MW preset stations are erased. To reset the interval, repeat the same procedure.

### Tips

- The preset stations are retained for about a day if you disconnect the AC power cord or if a power failure occurs.
- You can label the preset stations (see page 55).

## Step 4: Using the detachable controller

The control panel is detachable (detachable controller), and you can use it as the remote controller when you detach it from the main unit.

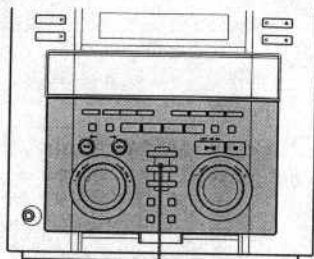

Detach controller

### Detaching the controller

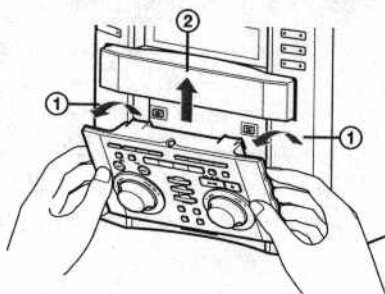

- ① Grasp both sides of the detachable controller.
- ② Lift out.

While the controller is detached, cover the detachable controller terminal with the supplied terminal protector to prevent dust builds up.

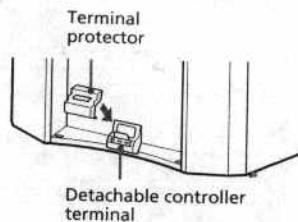

Terminal protector

Detach controller terminal

### Reattaching the detachable controller

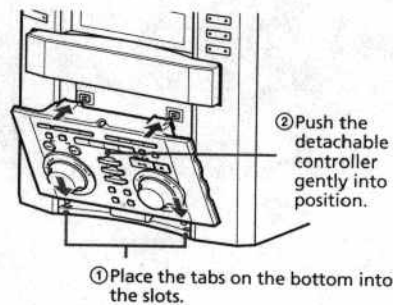

- ① Place the tabs on the bottom into the slots.
- ② Push the detachable controller gently into position.

#### Notes

- When you do not use the detachable controller, be sure to reattach it on the main unit to prevent losing it.
- Make sure that the detachable controller is placed securely. If not, the system may not work correctly.

### Inserting two size AA (R6) batteries into the detachable controller

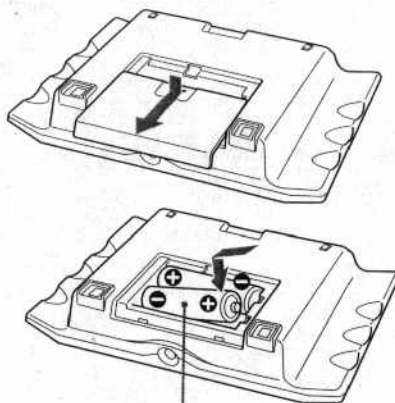

Size AA (R6) battery

#### Tip

When the detachable controller no longer operates the system, replace both batteries with new ones. When you do not use the detachable controller, reattach it on the main unit to save batteries.

#### Notes on the batteries

- Be sure to insert the batteries in correct direction.
- Do not mix new batteries with old ones.
- Do not use different types of batteries together.
- Do not use a battery that is leaking.
- If the battery leaks, clean the battery compartment and replace all the batteries with new ones.

### Using the detachable controller from a distance

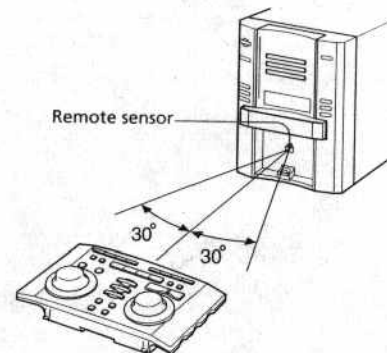

Remote sensor

Point the detachable controller at the remote sensor on the main unit.

#### To use an optional remote

When using an optional remote with the detachable controller attached, point it at the remote sensor in the upper left corner of the main unit.

Remote sensor (with the detachable controller attached)

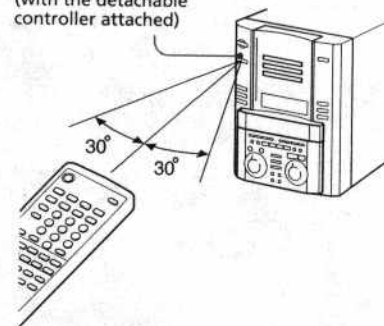

When the detachable controller is detached, point an optional remote at the remote sensor at the bottom of the main unit. The remote sensor in the upper left corner of the main unit does not work when the detachable controller is detached.

## Connecting optional A/V components and outdoor antennas

To enhance your system, you can connect optional components. Refer to the instructions of each component.

### Connecting a video game or VCR

Connect the plugs to jacks of the same color.

To the audio output of a video game or VCR

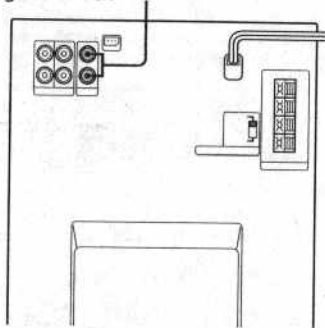

#### To listen to the VCR sound

Press FUNCTION repeatedly until "VIDEO" appears.

#### To listen to the video game sound

Press FUNCTION repeatedly until "GAME" appears.

If "GAME" does not appear when pressing FUNCTION, change the "VIDEO" indication to "GAME" following the procedure below.

- 1 Press FUNCTION repeatedly until "VIDEO" appears.
- 2 Press EDIT/NO.  
"GAME ?" appears.
- 3 Press ENTER/YES.  
Press EDIT/NO again to change the indication back to "VIDEO."

#### Note on the "VIDEO" and "GAME" indications

Change the indications according to the component connected to VIDEO/GAME IN.

- When you connect a VCR, AM/FM tuner or tape deck, select "VIDEO."
- When you connect a video game, multi disc player or DAT deck, select "GAME."
- If the sound is distorted when "VIDEO" is selected, change to "GAME."

### Connecting audio components

#### Connecting a tape deck

Connect the plugs to jacks of the same color.

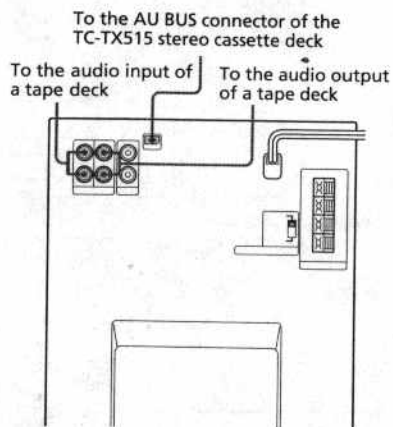

#### To listen to the tape deck sound

Press TAPE.

#### Tips

- When you connect the TC-TX515 stereo cassette deck to the DHC-MD515, be sure to use the AU BUS terminals. For details, refer to the instruction supplied with the TC-TX515.
- The (A) and (B) markings under the TAPE IN/OUT jacks guide you to connect the optional TC-TX515 deck.

#### Note

You cannot connect a turntable which does not have a built-in equalizer.

### Connecting outdoor antennas

Connect an outdoor antenna to improve reception.

#### FM antenna

Connect an optional FM outdoor antenna. You can use the TV antenna instead.

##### European model

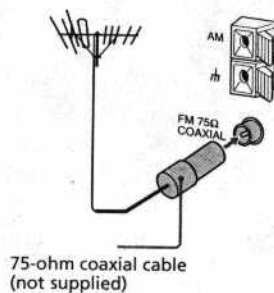

##### Other models

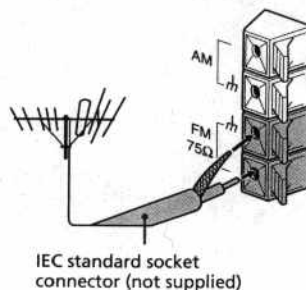

#### AM antenna

Connect a 6 to 15 meter (20 to 50 feet) insulated wire to the AM antenna terminal. Leave the supplied AM loop antenna connected.

##### European model

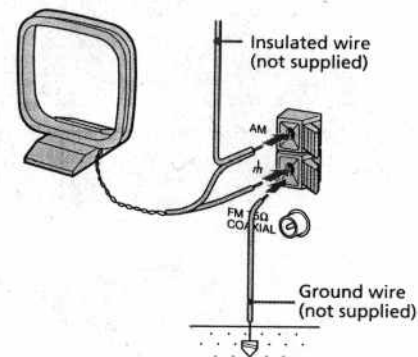

##### Other models

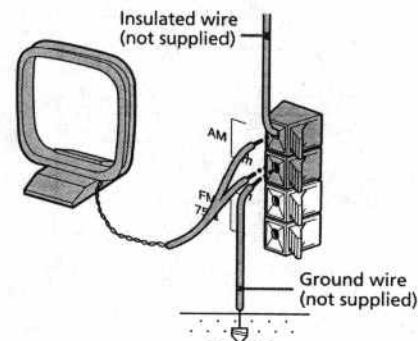

#### Important

If you connect an outdoor antenna, also connect a ground wire to protect your system from lightning. To prevent a gas explosion, do not connect the ground wire to a gas pipe.

## Basic Operations

### Playing a CD

You can play all the tracks on a CD in the original order and also play up to three CDs continuously. To turn on the system, press POWER.

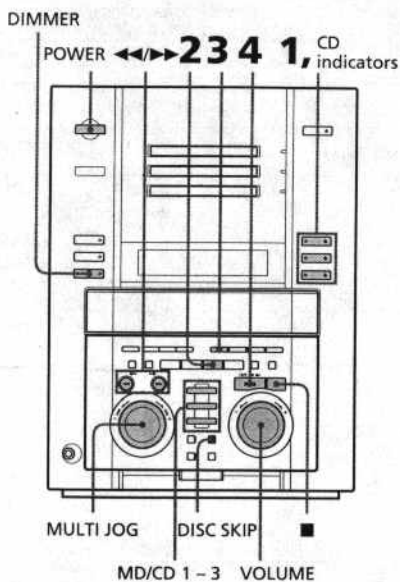

- 1 Press one of the CD 1 ▲ - CD 3 ▲ buttons to open the disc tray and place a CD on the tray.

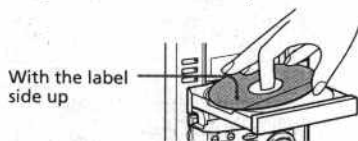

The disc tray closes when you press the CD 1 ▲ - CD 3 ▲ button again. To insert other CDs, press other CD 1 ▲ - CD 3 ▲ buttons, then place the CDs on the tray.

- 2 Press the CD button to switch the function to CD.

- 3 Press CONTINUE repeatedly until "ALL DISCS" appears. To play only one CD, press CONTINUE until "1 DISC" appears.

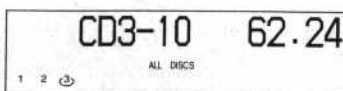

- 4 Press ►||. Play starts from the CD whose CD indicator is lit green.

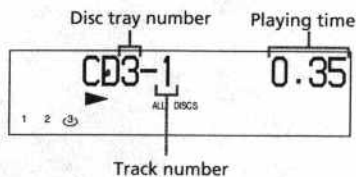

To start play from another CD, press MD/CD 1 - 3 corresponding to the disc tray number of the desired CD.

| To                      | Do this   |
|-------------------------|---|
| Stop play               | Press ■.  |
| Pause                   | Press ►  . Press again to resume play.  |
| Select a track          | Turn MULTI JOG clockwise (to go forward) or counterclockwise (to go back) until you locate the desired track.   |
| Find a point in a track | Press ◀◀ or ▶▶ during play and release it at the desired point. "OVER" appears when reaching the end of the CD.   |
| Select a CD             | <ul style="list-style-type: none"> <li>• Press MD/CD 1 - 3. Play starts soon after you press the button.</li> <li>• Press DISC SKIP repeatedly so that the desired CD indicator lights green. Press ►   to start playing the CD.</li> </ul> <p>If you press the DISC SKIP button during play, the CD changes and play starts automatically.</p> |
| Remove or exchange CD   | Press the CD 1 ▲ - CD 3 ▲ button of the CD you want to remove.  |
| Adjust the volume       | Turn VOLUME.  |

#### Tips

- In step 4, you can start playing from any track.
  - 1 Press DISC SKIP to select the desired CD.
  - 2 Turn MULTI JOG until the desired track number appears.
  - 3 Press ►||.
- The CD 1 ▲ - CD 3 ▲ indicators indicate the following.
  - Green: The disc tray is selected or being played.
  - Orange: A CD is inserted on the disc tray.
- If there is no CD in the player, "CD NO DISC" appears.
- You can change the brightness of the display. Each time you press the DIMMER button, the brightness changes as follows: Bright → Dimmed → Dimmest

#### Notes

- Close the disc tray by pressing the CD 1 ▲ - CD 3 ▲ button. If you push the disc tray with your hands to close it, it may damage the system.
- Do not use a CD with tape, seal or paste on it. It may damage the CD or system.

### Recording a whole CD on an MD

#### — CD-MD Synchro Recording

You can make a digital recording of a whole CD on an MD. If you use an MD with tracks already recorded on it, the MD deck automatically locates the end of the recording and starts the new recording from there. If you want to erase recordings, see page 47.

This system has other recording methods as well (see "Recording methods on this system" on page 34). Select one of them according to your needs.

To turn on the system, press POWER.

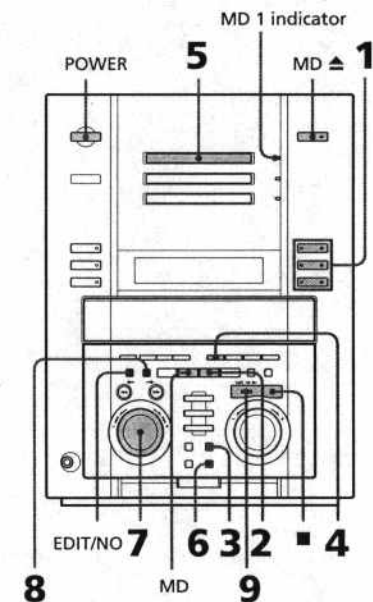

## Recording a whole CD on an MD (continued)

### Step 1: Preparing CD for recording

- 1 Press one of the CD 1 ▲ - CD 3 ▲ buttons to open the disc tray and place a CD on the tray.

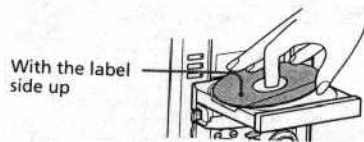

With the label side up

The disc tray closes when you press the CD 1 ▲ - CD 3 ▲ button again.

- 2 Press the CD button to switch the function to CD.
- 3 Press DISC SKIP repeatedly to select the desired CD.  
The selected CD 1 ▲ - CD 3 ▲ indicator lights green.
- 4 Press CONTINUE repeatedly until "1 DISC" appears.

### Step 2: Recording

- 5 Insert a recordable MD in the MD 1 slot.  
Insert the MD securely so that it clicks into place. If no MD is inserted, the MD is automatically loaded after a while. If MDs are inserted in other slots, the MD you inserted in the MD 1 slot is automatically loaded after pressing the ENTER/YES button in step 8.

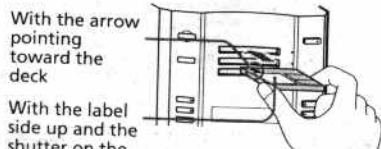

With the arrow pointing toward the deck

With the label side up and the shutter on the right

- 6 Press REC/CD-MD SYNC.

- 7 Turn MULTI JOG until "NORMAL ?" appears.

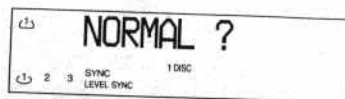

- 8 Press ENTER/YES.  
"SYNC" starts flashing, then remains lit in the display. The MD deck stands by for recording and the CD pauses at the beginning.

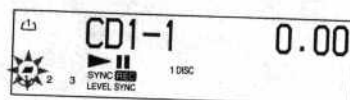

- 9 Make sure that "SYNC" stops flashing, then press ►||.  
Recording starts.  
Both the CD player and the MD deck stop automatically when the recording is completed.  
To stop recording, press ■.

#### To cancel CD-MD Synchro Recording

Press EDIT/NO at any point from step 6 to 9.

#### To stop CD-MD Synchro Recording

Press ■.

#### If an MD is already loaded

Insert a recordable MD after removing the loaded MD following the procedure below.

- 1 Press MD ▲.  
The MD is released and ejected.
- 2 Pull the MD from the slot.

#### When recording is finished

Remove the MD. "TOC Write" flashes and the recorded contents are memorized on the MD.

#### While "TOC Write" is flashing

Do not move the unit or pull out the AC power cord to ensure complete recording. The deck updates the Table of Contents (TOC) while "TOC" is flashing.

#### If the MD ends while recording

Both the CD player and MD deck stop automatically.

#### Tips

- The track numbers and disc title of the CD (see page 25) are copied on the MD when using a brand-new recordable MD or an MD whose tracks have been completely erased (see page 48) (Disc Memo Copy function). Note that the CD-TEXT information is not labeled on the MD depending on CDs.
- If you record on an MD with tracks already recorded on it, the recorded CD tracks are renumbered.

#### Notes

- You can record only on the MD inserted in the MD 1 slot when using this recording method.
- If "MD Protected" appears, the MD is protected against erasure and cannot be recorded. Press MD ▲ to eject the MD, then slide the tab on the side of the MD to close the slot (see page 33).

## Playing an MD

You can play all the tracks on an MD in the original order and also play up to three MDs continuously just like CDs. To turn on the system, press POWER.

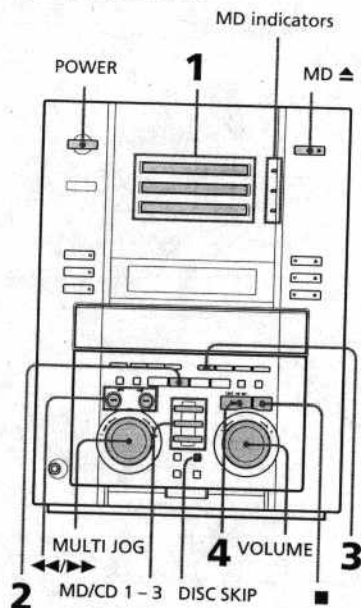

- 1 Insert an MD.  
Insert the MD securely so that it clicks into place. Make sure that the MD indicator lights orange or green.

With the arrow pointing toward the deck

With the label side up and the shutter on the right

- 2 Press the MD button to switch the function to MD.

continued



## Playing an MD (continued)

- 3** Press CONTINUE repeatedly until "ALL DISCS" appears.

To play only one MD, press the button until "1 DISC" appears.

- 4** Press **▶||**.

Play starts from the MD whose MD indicator is lit green.

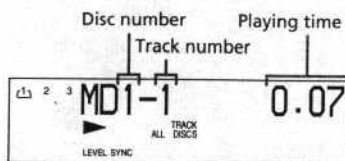

To start play from another MD, press MD/CD 1-3 corresponding to the disc slot number of the desired MD.

| To                      | Do this  |
|-------------------------|--|
| Stop play               | Press <b>■</b> .   |
| Pause                   | Press <b>▶  </b> . Press again to resume play.   |
| Select a track          | Turn MULTI JOG clockwise (to go forward) or counterclockwise (to go back) until you locate the desired track.  |
| Find a point in a track | Press <b>◀</b> or <b>▶</b> during play and release it at the desired point.  |
| Select an MD            | <ul style="list-style-type: none"> <li>Press MD/CD 1-3. Play starts soon after you press the button.</li> <li>Press DISC SKIP repeatedly so that the desired MD indicator lights green. Press <b>▶  </b> to start playing the MD.</li> </ul> <p>If you press the DISC SKIP button during play, the MD changes and play starts automatically.</p> |
| Remove the MD           | Press MD <b>▲</b> . When the MD is ejected, pull it from the slot.   |
| Adjust the volume       | Turn VOLUME.   |

## Tips

- The MD indicators indicate the following.
  - Green: The disc slot is selected or being played.
  - Orange: An MD is inserted in the slot.
- In step 4, you can start playing from any track.
  - Press DISC SKIP to select the desired MD.
    - The MD indicator of the desired MD lights green.
  - Turn MULTI JOG until the desired track number appears.
  - Press **▶||**.

## Listening to the radio

First, preset radio stations in the tuner's memory (see page 6). To turn on the system, press POWER.

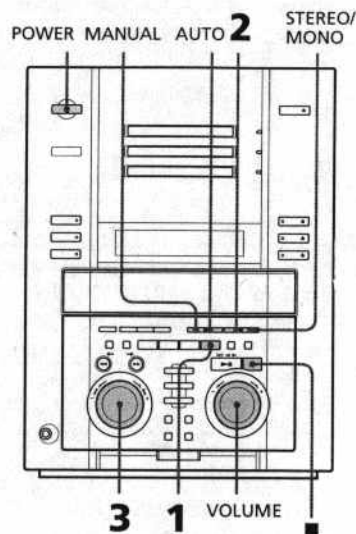

- 1** Press TUNER repeatedly until the band you want appears. Each time you press the button, the band changes as follows:

### North American model:

FM → AM  
↑

### European model:

FM → MW → LW  
↑

### Other models:

FM → MW → SW  
↑

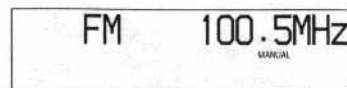

- 2** Press PRESET.

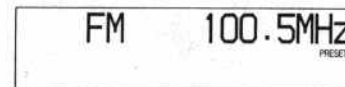

- 3** Turn MULTI JOG to tune in the desired preset station.

Turn counterclockwise for lower preset numbers. Turn clockwise for higher preset numbers.

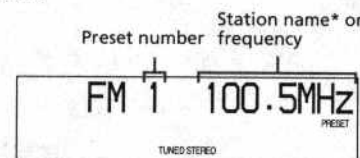

\* Station name appears only when you have labeled the station (see page 55).

| To                 | Do this      |
|--------------------|--------------|
| Turn off the radio | Press POWER. |
| Adjust the volume  | Turn VOLUME. |

## To listen to non-preset radio stations

- Press MANUAL in step 2, then turn MULTI JOG to tune in the desired station (Manual Tuning).
- Press AUTO in step 2, then turn MULTI JOG. The frequency indication changes and scanning stops when the system tunes in a station (Automatic Tuning).

## To cancel Automatic Tuning

Press **■**.

## Tips

- You can switch from another source to the tuner just by pressing TUNER (Automatic Source Selection).
- To improve broadcast reception, reorient the supplied antennas.
- When an FM program is noisy, press STEREO/MONO until "MONO" appears. There will be no stereo effect, but the reception will improve. Press the button again to restore the stereo effect.

## Recording from the radio

You can record a radio program on an MD. If you use an MD with tracks already recorded on it, the MD deck automatically locates the end of the recording and starts the new recording from there. If you want to erase recordings, see page 47. To turn on the system, press POWER.

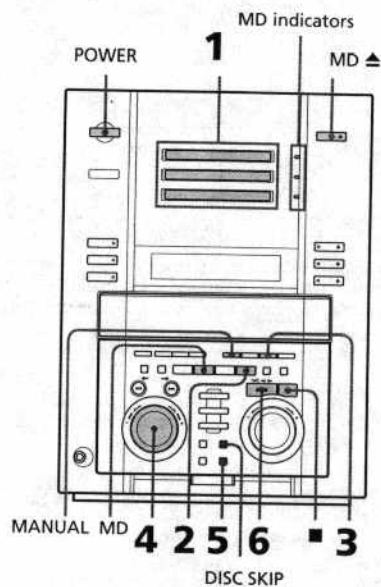

- 1 Insert a recordable MD.  
Load an MD following the procedure in "To load an MD." You can record on any MDs inserted in MD 1-3 slots.

With the arrow pointing toward the deck  
With the label side up and the shutter on the right

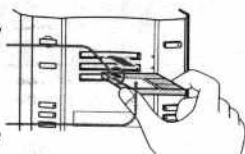

- 2 Press TUNER repeatedly until the band you want appears.
- 3 Press PRESET.
- 4 Turn MULTI JOG to select the preset number of the desired station.

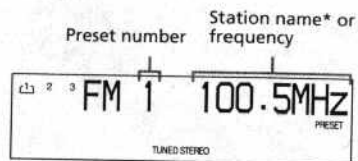

\* Station name appears only when you have labeled the station (see page 55).

- 5 Press REC/CD-MD SYNC.  
The MD deck stands by for recording.
- 6 Press ► II.  
Recording starts.

### To stop recording

Press ■.

### To record non-preset radio stations

Press MANUAL in step 3, then turn MULTI JOG to tune in the desired station.

### To load an MD

- 1 Press the MD button to switch the function to MD.
- 2 Press DISC SKIP repeatedly so that the MD indicator of the slot where a recordable MD is inserted lights green.
- 3 Press MD ▲.  
When an MD is already loaded, the loaded MD is ejected and the selected MD is loaded.

### When recording is finished

Remove the MD. "TOC Write" flashes and the recorded contents are memorized on the MD.

### While "TOC Write" is flashing

Do not move the unit or pull out the AC power cord to ensure complete recording. The deck updates the Table of Contents (TOC) while "TOC" is flashing.

### Tip

If noise is heard while recording an AM (MW/LW, MW/SW) radio station, reorient the AM loop antenna to reduce the noise.

### Note

If "MD Protected" appears, the MD is protected against erasure and cannot be recorded. Press MD ▲ to eject the MD, then slide the tab on the side of the MD to close the slot (see page 33).

## The CD Player

### Playing CD tracks repeatedly

#### — Repeat Play

You can repeat one CD or all CDs in normal play, Shuffle Play and Program Play.

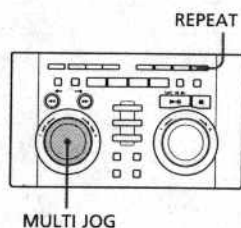

#### Repeating all tracks or a program

Press REPEAT during play until "REPEAT" appears.

You cannot repeat all tracks during All Discs Shuffle Play.

#### Repeating only one track

While playing the desired track, press REPEAT repeatedly until "REPEAT 1" appears.

You can change the track to be repeated by turning MULTI JOG during play.

You cannot repeat only one track during Shuffle or Program Play.

#### To cancel Repeat Play

Press REPEAT repeatedly until "REPEAT" or "REPEAT 1" disappears.

### Playing CD tracks in random order

#### — Shuffle Play

You can play all the tracks on one CD or all CDs in random order.

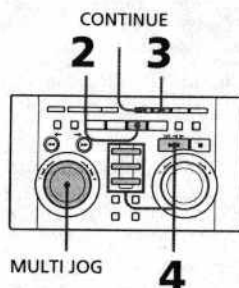

1 Insert CDs.

2 Press the CD button to switch the function to CD.

3 Press SHUFFLE.

Each time you press the button, the display changes as follows:

|  |   |   |
|--|---|---|
| "ALL DISCS"<br>(All the CDs play in random order.) | ↔ | "1 DISC"<br>(The tracks on the CD whose CD 1 ▲ - CD 3 ▲ indicator is lit green play in random order.) |
|--|---|---|

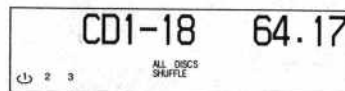

4 When selecting "ALL DISCS," press ►||. When selecting "1 DISC," press MD/CD 1-3 corresponding to the disc tray number of the desired CD.

" 3" appears, and all the tracks play in random order.

#### To cancel Shuffle Play

Press CONTINUE.

#### Tips

- You can start Shuffle Play during normal play by pressing the SHUFFLE button. The CD player shuffles all the tracks including the ones which have been played.
- To skip a track, turn MULTI JOG clockwise.

#### Note

During All Discs Shuffle Play, you cannot use the repeat function.

### Programming CD tracks

#### — Program Play

You can make three different programs from all the CDs in the order you want them to be played. Each program can contain up to 25 steps. You can make Synchro Recordings of programs on MDs (see page 37).

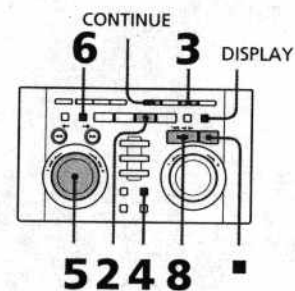

1 Insert CDs.

2 Press the CD button to switch the function to CD.

#### Notes

- You can program tracks only in stop mode.
- Make sure that the total number of tracks and the playing time appear in the display, then go to the next step.

3 Press PROGRAM repeatedly until the desired program number ("PROGRAM 1" - "PROGRAM 3") appears.

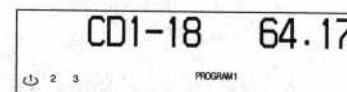

## Programming CD tracks (continued)

- 4** Press DISC SKIP to select the desired CD.

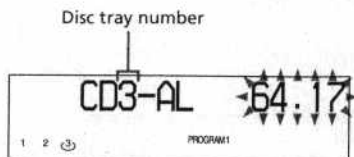

- 5** Turn MULTI JOG to select the desired track.  
The total playing time including the selected track flashes.

Selected disc and track numbers

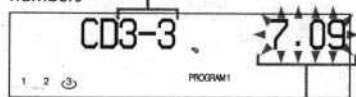

- 6** Press ENTER/YES.  
The track is programmed.  
The total number of programmed steps appears, followed by the total playing time of the program.

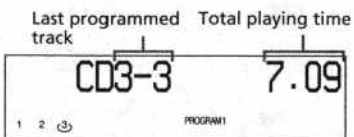

- 7** To program additional tracks, repeat steps 4 through 6.  
Skip step 4 if you want to select a track from the same CD.

- 8** Press ►||.  
All the tracks play in the order you selected.

## To cancel Program Play

Press CONTINUE.

## To cancel programming tracks

Press ■ at any point from step 4 to 6.

## To play a previously created program

Press PROGRAM repeatedly until the desired program number appears, then press ►||.

## To erase the entire program

Press PROGRAM repeatedly until the program number you want to erase appears, then press ■ once in stop mode.

## To check the programmed track number

In stop mode, press PROGRAM repeatedly until the program number you want to check appears, then press DISPLAY.

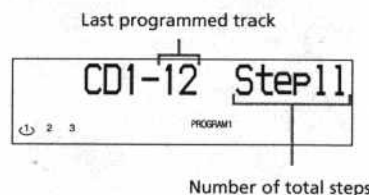

## To check the programmed track order

Turn MULTI JOG during Program Play.

## To add a track to the program

- In stop mode, press PROGRAM repeatedly until the program number you want appears.
- Press DISC SKIP to select the desired CD.
- Turn MULTI JOG to select the desired track, then press ENTER/YES.  
The selected track is added to the end of the program.

## Tips

- To program the entire CD as one step of the program, press ENTER/YES while "AL" appears after selecting the desired CD in step 4.
- When you want to record the program, see "Recording your favorite CD tracks on MDs" on page 37.
- The program you made remains after Program Play finishes. To play the same program again, press ►||. However, when you make a recording with the Hit Parade feature (page 39), PROGRAM 3 is erased.
- If you press the CD 1 ▲ - CD 3 ▲ button to open the disc tray, the tracks of the CD inserted in the tray are erased from the program.
- "---" appears instead of the total playing time when the total program time exceeds 100 minutes.

## Using the CD display

You can check the remaining time of the current track or the entire CD.

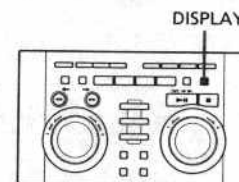

Press DISPLAY repeatedly during play.  
Each time you press the button, the display changes as follows:

- Elapsed time of the current track
- ↓
- Remaining time of the current track
- ↓
- Remaining time of the current CD<sup>1)</sup>
- ↓
- Track title<sup>2)</sup> (only for CDs with CD-TEXT)
- ↓
- Clock
- ↓
- Preset Equalizer menu

<sup>1)</sup> The remaining time of the CD is not displayed during Program or Shuffle Play.

<sup>2)</sup> "No Name" appears while playing a CD without CD-TEXT information of track titles.

## Using the CD display (continued)

### To check the total playing time and number of tracks on the CD

Press DISPLAY repeatedly during normal or Shuffle Play stop mode.

Each time you press the button, the display changes as follows:

- Total playing time and the number of tracks
- ↓
- Disc title<sup>3)</sup>
- ↓
- Clock
- ↓
- Preset Equalizer menu

<sup>3)</sup> "No Name" appears when the CD is not assigned a disc title. When you press the DISPLAY button while selecting a CD with CD-TEXT information including artist name, the artist name scrolls in the display following the disc title, then the display returns to the total playing time and the number of tracks.

#### Tip

"-.-" appears when you check the remaining time of a track numbered over 20.

## Looping part of a CD track

### — Loop

With the loop function, you can repeat part of a CD track during play. This lets you create original recordings. You can choose the Loop length among 20 levels.

#### Original

Hey, Come on everybody! ...

#### Loop

Hey, C, C, C Come on everybody! ...

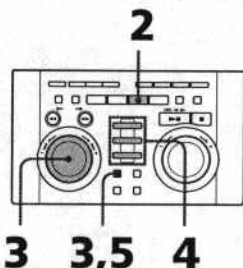

- 1 Insert a CD.
- 2 Press the CD button to switch the function to CD.
- 3 While holding down CD LOOP, turn MULTI JOG to select the loop length ("LOOP 1 - 20").  
The loop length becomes longer as the number increases.
- 4 Press the MD/CD 1 - 3 button of the desired CD to start playing.

- 5 Press and hold CD LOOP at the point you want to start the Loop function, and release the button to resume normal play.

The track pauses while the loop plays, then resumes play from the same point when you release the button.

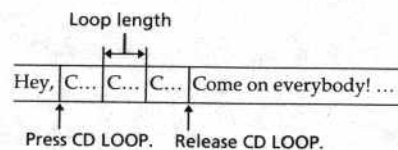

### To adjust the loop length while monitoring

In step 5, turn MULTI JOG while holding down CD LOOP.

The loop length changes.

## Labeling a CD

You can label up to 100 CDs with titles of up to 20 symbols and characters. The titles you labeled are stored in the system's memory and each title (disc name) appears in the display whenever you insert the labeled CD. If you label a CD and make a CD-MD Synchro Recording on a blank MD, the title is automatically recorded on the MD (**Disc Memo Copy function**).

#### Notes

- If you label a CD with CD-TEXT information (see page 27), the disc title you labeled appears instead of the disc title of the CD-TEXT information.
- When you label CDs for the first time, do the procedure in "Erasing all disc titles stored in memory" on page 27 beforehand.

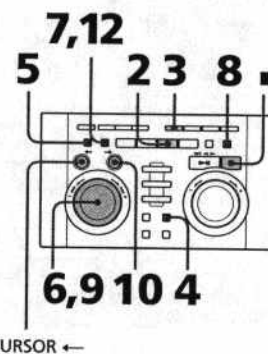

- 1 Insert a CD.
  - 2 Press the CD button to switch the function to CD.
- Note**  
You can label CDs only in stop mode.
- 3 Press CONTINUE.

## Labeling a CD (continued)

- 4** Press DISC SKIP repeatedly until the disc tray number of the desired CD appears.  
Make sure the total number of tracks and the playing time appear in the display, then go to the next step.

- 5** Press EDIT/NO.

- 6** Turn MULTI JOG until "CD Name in?" appears.



- 7** Press ENTER/YES.  
The cursor starts flashing.

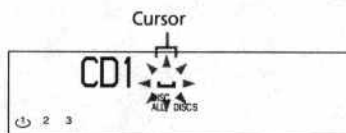

- 8** Press DISPLAY repeatedly until the type of character you want appears. Each time you press the button, the display changes as follows:

A (Upper case) → a (Lower case) → 0 (Numbers) → ! (Symbols)\* → ␣ (Space) → A...

\*You can use the following symbols.

!"#\$%&'()\*+,-./:;<=>?@\_`

- 9** Turn MULTI JOG until the desired character appears.  
To enter a blank space, go to the next step without turning MULTI JOG. A blank space cannot be entered in the first position.

- 10** Press CURSOR →.  
The character you selected in step 9 stops flashing and the cursor shifts to the right.

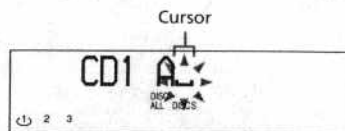

- 11** Repeat steps 8 through 10 to complete the entire title.  
If you make a mistake, press CURSOR ← or → until the character you want to change flashes, then repeat steps 8 through 10.  
To erase a character, press EDIT/NO. Each time you press the button, the flashing character is erased. You cannot insert a character between previously input characters.

- 12** Press ENTER/YES to complete the labeling procedure.  
The disc title is stored in the system's memory.

### To cancel labeling

Press ■ at any point from step 6 to 11.

## Checking the disc titles stored in memory

- 1** In step 6 of "Labeling a CD," turn MULTI JOG until "CD Name Check?" appears, then press ENTER/YES.  
**2** Turn MULTI JOG to select CD 1 - 3 or the stored disc titles (001 - 100) you want to check.  
The disc title scrolls in the display.

## Erasing a disc title of a CD

- 1** In step 6 of "Labeling a CD," turn MULTI JOG until "CD Name Erase?" appears, then press ENTER/YES.  
The disc title scrolls in the display.  
**2** Turn MULTI JOG to select CD 1 - 3 or the stored disc titles (001 - 100) you want to erase.  
**3** Press ENTER/YES to erase the disc title.  
"CD Complete" appears and the disc title is erased.

### To cancel erasing a disc title

Press ■ at any point from step 1 to 2.

## Erasing all disc titles stored in memory

- 1** In step 6 of "Labeling a CD," turn MULTI JOG until "CD All Erase?" appears, then press ENTER/YES.  
"CD All Erase??" appears.  
**2** Press ENTER/YES to erase all disc titles.  
"CD Complete" appears and all disc titles are erased.

### To cancel erasing all disc titles

Press ■ in step 1.

### Note

When you make a recording with the Hit Parade feature (page 39), the disc title is not labeled on the MD.

## Checking the CD-TEXT information

When you select a CD with CD-TEXT information (disc title, artist name, track title, etc. memorized on the CD), you can enjoy playback while checking the artist name or current track title.

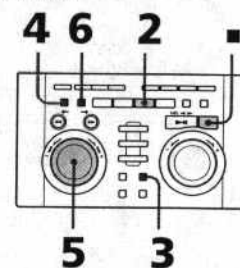

## Checking the disc titles

- 1** Insert a CD.  
**2** Press the CD button to switch the function to CD.  
**3** Press DISC SKIP repeatedly to select the CD you want to check.  
**4** Press EDIT/NO.  
**5** Turn MULTI JOG until "CD Name Check?" appears.



- 6** Press ENTER/YES.  
The disc title scrolls in the display.

## Checking the CD-TEXT information (continued)

### Checking the track titles

Turn MULTI JOG to select the track you want to check in either playing or stop mode.

The track title scrolls in the display.



### To cancel checking

Press ■.

### To check the CD-TEXT information during play

- 1 Press EDIT/NO.
- 2 Turn MULTI JOG until "CD Name Check?" appears.
- 3 Press ENTER/YES.  
The display shows the title information up to 20th character.

### Notes

- The CD-TEXT information is not recorded on MDs depending on CDs.
- If the disc title of CD-TEXT information exceeds 20 characters, the characters after the 20th do not appear.

## The MD Deck - Playing

### Playing MD tracks repeatedly

#### — Repeat Play

You can repeat one MD or all MDs in normal play, Shuffle Play and Program Play.

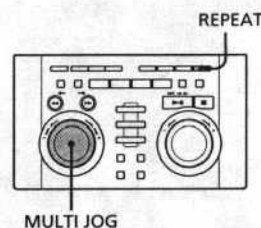

### Repeating all tracks or a program

Press REPEAT during play until "REPEAT" appears.

You cannot repeat all tracks during All Discs Shuffle Play.

### Repeating only one track

While playing the desired track, press REPEAT repeatedly until "REPEAT 1" appears.

You can change the track to be repeated by turning MULTI JOG during play.

You cannot repeat only one track during Shuffle or Program Play.

### To cancel Repeat Play

Press REPEAT repeatedly until "REPEAT" or "REPEAT 1" disappears.

### Playing MD tracks in random order

#### — Shuffle Play

You can play the tracks on one MD or all MDs in random order.



1 Insert an MD.

2 Press the MD button to switch the function to MD.

3 Press SHUFFLE in stop mode.

Each time you press the button, the display changes as follows:

"ALL DISCS"  
(All the MDs play in random order.)

↔ "1 DISC"  
(The tracks on the MD whose MD 1 - 3 indicator is lit green play in random order.)

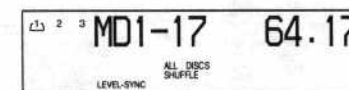

4 When selecting "ALL DISCS," press ►||. When selecting "1 DISC," press the MD/CD 1 - 3 button corresponding to the slot number of the desired MD. "⏮" appears, then all the tracks play in random order.

## Playing MD tracks in random order (continued)

### To cancel Shuffle Play

Press ■ to stop play, then CONTINUE.

### Tip

To skip tracks, turn the MULTI JOG clockwise.

### Notes

- During All Discs Shuffle Play, you cannot use the repeat function.
- "MD Push STOP !" appears if you press the CONTINUE, SHUFFLE or PROGRAM button to change the play mode while playing an MD. When you want to change the play mode, press ■ to stop play.

## Programming MD tracks

### — Program Play

You can make a program of up to 25 tracks from all the MDs in the order you want them to be played.

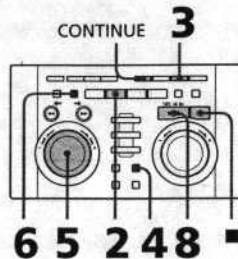

- 1 Insert an MD.
- 2 Press the MD button to switch the function to MD.  
**Notes**
  - You can program tracks only in stop mode.
  - Make sure that the total number of tracks and the playing time appear in the display, then go to the next step.
- 3 Press PROGRAM in stop mode.
- 4 Press DISC SKIP to select the desired MD.

Slot number of the selected MD

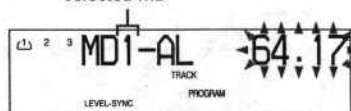

- 5 Turn MULTI JOG to select the desired track.

- 6 Press ENTER/YES.  
The track is programmed. The total number of programmed steps appears, followed by the total playing time of the program.

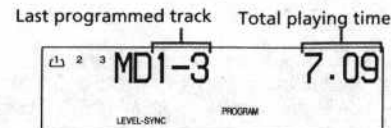

- 7 Repeat steps 4 through 6 to program other tracks.
- 8 Press ►||.  
All the tracks play in the order you selected.

### To cancel Program Play

Press ■ to stop play, then CONTINUE.

### To cancel programming tracks

Press ■ at any point from step 4 to 6.

### To erase the entire program

Press ■ once in program stop mode.

### To add a track to the end of the program

- 1 In stop mode, turn MULTI JOG until the desired track number appears.
- 2 Press ENTER/YES.  
The selected track is added to the end of the program.

### Tips

- To program the entire MD as one step of the program, press ENTER/YES while "AL" appears after selecting the desired MD in step 4.
- The program you made remains after Program Play finishes. To play the same program again, press ►||.
- If you eject an MD from the MD 1 - 3 slot, the tracks of the ejected MD are erased from the program.
- "..." appears instead of the total playing time when the total program time exceeds 100 minutes.



## Using the MD display

You can check the remaining time of the current track or the entire MD.

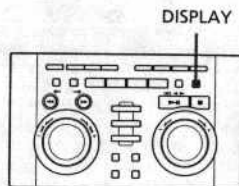

## Checking the remaining time of a track

Press DISPLAY during play. Each time you press the button, the display changes as follows:

- Playing time and track number of the current track
- ↓
- Remaining time and track number of the current track
- ↓
- Track title of the current track<sup>1)</sup>
- ↓
- Clock
- ↓
- Preset Equalizer menu

<sup>1)</sup> "No Name" appears if no track title is stored. To label a track, see page 46.

## Checking the remaining time of an MD

Press DISPLAY in stop mode. Each time you press the button, the display changes as follows:

- Total playing time and track number on the MD
- ↓
- Remaining recordable time on the MD (only for a recordable MD)
- ↓
- Disc title<sup>2)</sup>
- ↓
- Clock
- ↓
- Preset Equalizer menu

<sup>2)</sup> "No Name" appears if no disc title is stored. To label an MD, see page 46.

## The MD Deck - Recording

### Before you start recording

MDs (Mini Disc) let you digitally record and play music with high quality sound. Another feature of MDs is track marking. The track marking feature lets you quickly locate a specific point or easily edit the recorded tracks. However, depending on the source you record, the recording method varies. Also, the way the track numbers are recorded differs depending on the source.

#### When the source you record from is:

##### • This system's CD player

- The digital signal from the CD is recorded as it is (digital recording<sup>1)</sup>).
- Track numbers are automatically marked as on the original CD.

##### • Other digital components (for example, a DAT deck)

- The digital signal is converted to an analog signal, then re-converted to a digital signal and recorded<sup>2)</sup> (analog recording).
- A track number is marked at the beginning of a recording, but when you turn on the Level Synchro function (see page 43), track numbers are automatically marked in sync with the level of the input signal.

##### • This system's tuner or other analog components (for example, a tape deck)

- The analog signal is converted to a digital signal and recorded (analog recording).
- A track number is marked at the beginning of a recording, but when you turn on the Level Synchro function (see page 43), track numbers are automatically marked in sync with the level of the input signal.

<sup>1)</sup> For details on the limitations for digital recording, see page 64.

<sup>2)</sup> This signal is converted because this system does not have a digital input.

#### Note on MD track numbers

On an MD, the track number (track sequence), track start and end point information, etc., are recorded in the TOC<sup>3)</sup> area independent of the sound information. You can edit recorded tracks quickly by modifying the TOC information.

<sup>3)</sup> TOC: Table Of Contents

### After recording

Press MD ▲ and pull the MD, or press POWER to turn off the system.

"TOC Write" starts flashing. The MD deck updates the TOC information of the MD and the recording is completed.

#### Note

Recording on an MD is completed when the TOC writing is finished. If you pull out the AC power cord before TOC writing is finished, the recorded contents will not be memorized on the MD.

TOC writing starts when you do any of the following operations. Be sure to do the following before pulling out the AC power cord.

— Eject the MD.

— Press POWER to turn off the system.

#### Protecting a recorded MD

- To protect a recorded MD, slide the tab on the side of the MD to open the slot.

In this position, the MD cannot be recorded. To record on the MD, slide the tab to close the slot.

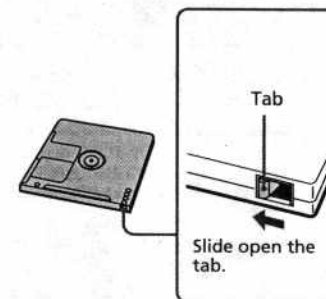

- If the MD is protected against erasure, "MD Protected" appears and the MD cannot be recorded. Slide the tab to close the slot.

## Recording methods on this system

This system offers you nine types of recording methods. Select one of those according to your needs.

### Recording a whole CD as it is

You can record a CD to an MD in the same sequence as the original CD.

- Recording one CD to an MD (CD-MD Synchro Recording, page 13)



- Recording three CDs in each disc number (CD 1 - 3) to each MD separately (3CD to 3MD Synchro Recording, page 35)

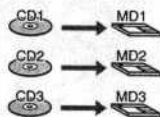

- Recording three CDs to MDs in sequence (Seamless Recording, page 36)

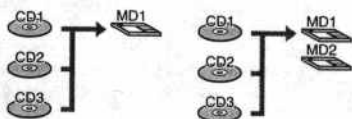

### Recording your favorite tracks

You can record the CD program you made to MDs. You can select the desired tracks from up to three CDs.

- Recording one program to an MD (page 37)

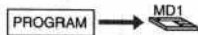

- Recording each program (program 1 - 3) to each MD separately (3PGM to 3MD, page 38)

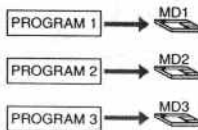

- Recording only the first track on each CD (Hit Parade, page 39)



- Recording the current CD track immediately (Rec It, page 40)

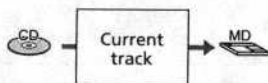

- Recording manually (page 41)

### Recording your favorite tracks

- Starting recording with 6 seconds of prestored audio data (Time Machine Recording, page 42)

When recording from an FM or satellite broadcast, you can prevent losing the material.

- Making a space between tracks 3 seconds long (Smart Space/ Auto Cut, page 44)

You can make a blank space between tracks three seconds long automatically while making a digital recording.

- Marking track numbers automatically while recording (Level Synchro Recording, page 43)

You can mark track numbers automatically using the blank portions between tracks.

- Marking track numbers at a specific point while recording (page 43)

You can mark track numbers at any time during analog or digital recording.

After recording, you can edit the recorded tracks, e.g., change the track order, erase the unwanted tracks.

## Recording multiple CDs on multiple MDs

### — 3CD to 3MD Synchro Recording

Each CD is recorded on the corresponding MD slot number. For example, CD 1 is recorded on MD 1, CD 2 on MD 2, and CD 3 on MD 3. Be sure to insert MDs into the appropriate corresponding slots.

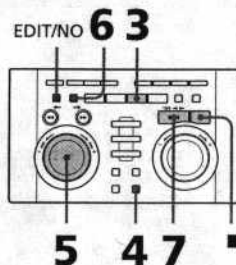

- Insert CDs.
- Insert recordable MDs into the slots corresponding to the disc tray number of inserted CDs.
- Press the CD button to switch the function to CD.
- Press REC/CD-MD SYNC.
- Turn MULTI JOG until "3CD → 3MD ?" appears.



- Press ENTER/YES. "SYNC" starts flashing, then remains lit in the display. The MD deck stands by for recording and the CD pauses at the beginning.



- Make sure that "SYNC" stops flashing, then press **II**.

Recording starts from CD 1 through CD 3. When the CD changes, the corresponding MD is loaded at the same time. Both the CD player and MD deck stop automatically when the recording of all CDs inserted in the disc tray is completed.

### To cancel recording

Press EDIT/NO at any point from step 3 to 5.

### To stop recording

Press **■**.

### When recording is finished

Remove the MD. "TOC Write" flashes and the recorded contents are memorized on the MD.

### While "TOC Write" is flashing

Do not move the unit or pull out the AC power cord to ensure complete recording. The deck updates the Table of Contents (TOC) while "TOC" is flashing.

### Tips

- The MD is labeled with the disc title of the CD (see page 46) when using a brand-new recordable MD or an MD whose tracks have been completely erased (see page 48) (Disc Memo Copy function). Note that the CD-TEXT information is not labeled on the MD depending on CDs.
- Recording of the current CD is skipped and recording of the next CD starts in the following cases:
  - There is no MD in the same disc number with the CD you want to record.
  - The MD is protected against erasure.
- When the MD becomes full in the middle of the recording, both CD and MD stop, and recording of the next CD starts.

## Recording multiple CDs on MDs in sequence

### — Seamless Recording

You can use this feature to record three CDs to MDs in sequence.

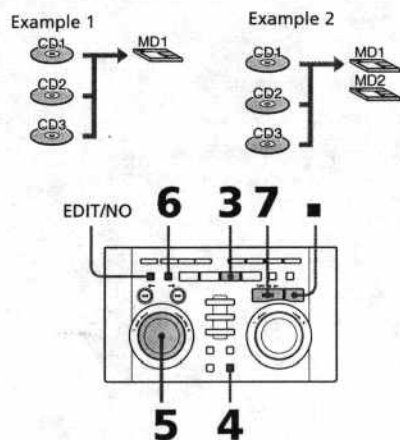

- 1 Insert CDs.
- 2 Insert a recordable MD.  
Recording starts from the MD in the MD 1 slot. Remove the MD you do not want to record on beforehand.
- 3 Press the CD button to switch the function to CD.
- 4 Press REC/CD-MD SYNC.
- 5 Turn MULTI JOG until "SEAMLESS ?" appears.



- 6 Press ENTER/YES.  
"SYNC" starts flashing, then remains lit in the display. The MD deck stands by for recording and the CD pauses at the beginning. If you use an MD with tracks already recorded on it, the MD deck automatically locates the end of the recording and starts the new recording from there.

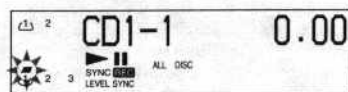

- 7 Make sure that "SYNC" stops flashing, then press **▶||**.  
CD starts playing and MD starts recording. If the MD in the MD 1 slot becomes full, the rest of the CD is recorded on the MD in the next slot number. Both the CD player and the MD deck stop automatically when the recording is completed.

#### To cancel recording

Press EDIT/NO at any point from step 3 to 5.

#### To stop recording

Press **■**.

#### When recording is finished

Remove the MD. "TOC Write" flashes and the recorded contents are memorized on the MD.

#### While "TOC Write" is flashing

Do not move the unit or pull out the AC power cord to ensure complete recording. The deck updates the Table of Contents (TOC) while "TOC" is flashing.

#### Notes

- The Disc Memo Copy function is not activated during Seamless Recording.
- If the MD in the MD 1 slot becomes full, the rest of the CD is recorded on the MD in the next slot number. Insert another recordable MD in the next slot and remove the MD you do not want to record on beforehand.

## Recording your favorite CD tracks on MDs

### — 3PGM to 3MD

After programming the desired tracks using the CD Program Play feature, you can record them on MDs with the CD-MD Synchro Recording feature.

- Recording one program on an MD
- Recording multiple programs on separate MDs (3PGM to 3MD)

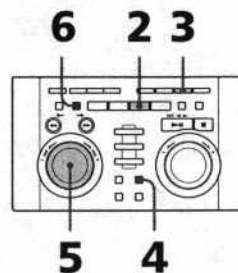

### Step 1: Programming the desired tracks

- 1 Insert CDs.
- 2 Press the CD button to switch the function to CD.
- 3 Press PROGRAM repeatedly until the desired program number ("PROGRAM 1" – "PROGRAM 3") appears.
- 4 Press DISC SKIP to select the desired CD.
- 5 Turn MULTI JOG until the desired track appears.

- 6 Press ENTER/YES.  
The track is programmed.  
The total number of programmed steps and total playing time of the program appear.

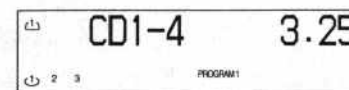

- 7 To program additional tracks, repeat steps 4 through 6.
- 8 To make another program in sequence, repeat steps 3 through 7.

### Step 2: Recording programs on MDs

Continue with either procedure below ("Recording one program" or "Recording multiple programs"), according to the number of programs to be recorded.

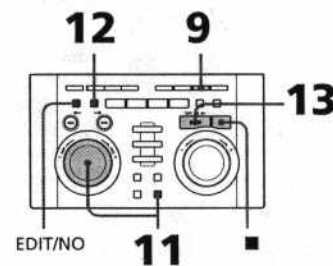

### – Recording one program

- 9 Press PROGRAM repeatedly until the desired program number ("PROGRAM 1" – "PROGRAM 3") appears.

### Recording your favorite CD tracks on MDs (continued)

**10** Insert a recordable MD in the MD 1 slot.

You can record only on the MD inserted in the MD 1 slot. If the MD 1 indicator is lit green, remove the already inserted MD.

**11** Press REC/CD-MD SYNC, then turn MULTI JOG until "NORMAL ?" appears..

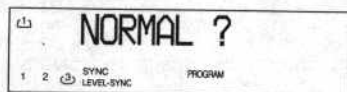

**12** Press ENTER/YES.

"SYNC" starts flashing, then remains lit in the display. The MD deck stands by for recording and the CD player pauses. If you use an MD with tracks already recorded on it, the MD deck automatically locates the end of the recording and starts the new recording from there.

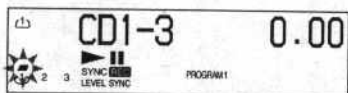

**13** Make sure that "SYNC" stops flashing, then press ►||.

CD starts playing and MD starts recording. Both the CD player and MD deck stop automatically when the recording is completed.

### - Recording multiple programs

**10** Insert recordable MDs into the slots corresponding to the desired program numbers.

**11** Press REC/CD-MD SYNC, then turn MULTI JOG until "3PGM → 3MD ?" appears.



**12** Press ENTER/YES.

"SYNC" starts flashing, then remains lit in the display. The MD deck stands by for recording and the CD player pauses. If you use an MD with tracks already recorded on it, the MD deck automatically locates the end of the recording and starts the new recording from there.



**13** Make sure that "SYNC" stops flashing, then press ►||.

Recording starts from the PROGRAM 1 through PROGRAM 3. When the program changes, the corresponding MD is loaded at the same time. Both the CD player and MD deck stop automatically when the recording is completed.

#### To cancel recording

Press ■ while programming the tracks, or EDIT/NO after pressing the REC/CD-MD SYNC button.

#### To stop recording

Press ■.

#### When recording is finished

Remove the MD. "TOC Write" flashes and the recorded contents are memorized on the MD.

#### While "TOC Write" is flashing

Do not move the unit or pull out the AC power cord to ensure complete recording. The deck updates the Table of Contents (TOC) while "TOC" is flashing.

#### Notes

- When recording only one program by selecting "NORMAL," you can record only on the MD in the MD 1 slot.
- When recording multiple programs, each program is recorded only on the MD inserted in the same slot number as the desired program number.
- When recording multiple programs by selecting "3PGM → 3MD," recording of the current program is skipped and recording of the next program starts in the following cases:
  - There is no MD in the same slot number as the program number you want to record.
  - The MD is protected against erasure.
- If the MD becomes full in the middle of the recording, both the CD player and MD deck stop. When recording multiple programs, recording of the next program starts.

## Recording only the first track on each CD

### - Hit Parade

This feature is useful when you record only the first track on each CD in succession.

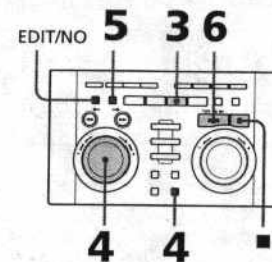

### Recording from three CDs

- 1 Insert CDs.
- 2 Insert a recordable MD in the MD 1 slot.  
You can record only on the MD inserted in the MD 1 slot. If the MD 1 indicator is lit green, press MD ▲ and remove the previously inserted MD.
- 3 Press the CD button to switch the function to CD.
- 4 Press REC/CD-MD SYNC, then turn MULTI JOG until "HIT PARADE ?" appears.



### Recording only the first track on each CD (continued)

- 5** Press ENTER/YES.  
“SYNC” starts flashing, then remains lit in the display. The MD deck stands by for recording and the CD player pauses. If you use an MD with tracks already recorded on it, the MD deck automatically locates the end of the recording and starts the new recording from there.



- 6** Make sure that “SYNC” stops flashing, then press ►||.  
CD starts playing and MD starts recording. Both the CD player and MD deck stop automatically when the recording is completed.

### Recording from four or more CDs

Repeat steps 1 and 4 through 6.

#### To cancel recording

Press EDIT/NO in step 4.

#### To stop recording

Press ■.

#### When recording is finished

Remove the MD. “TOC Write” flashes and the recorded contents are memorized on the MD.

#### While “TOC Write” is flashing

Do not move the unit or pull out the AC power cord to ensure complete recording. The deck updates the Table of Contents (TOC) while “TOC” is flashing.

#### Note

You can record only on the MD inserted in the MD 1 slot.

### Recording the current CD track

#### — Rec It

You can select the CD track you want to record while listening, then start recording immediately.

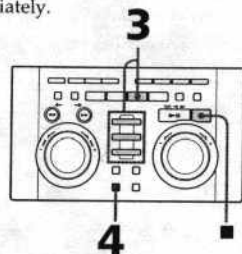

- 1** Insert a CD.  
**2** Insert a recordable MD (see page 18).  
You can record on any MDs inserted in MD 1 – 3 slots.  
**3** Press the CD button to switch the function to CD, then press MD/CD 1 – 3.  
CD starts playing.  
**4** Press REC IT when you find the desired track.  
The CD goes back to the beginning of the track, and recording starts. The MD deck stops automatically when the current track is finished.

#### To stop recording

Press ■.

#### When recording is finished

Remove the MD. “TOC Write” flashes and the recorded contents are memorized on the MD.

#### While “TOC Write” is flashing

Do not move the unit or pull out the AC power cord to ensure complete recording. The deck updates the Table of Contents (TOC) while “TOC” is flashing.

### Recording on an MD manually

This feature is useful when recording radio programs or from connected optional components. The system automatically locates the end of any recorded portion of an MD and starts recording from that point. To record from the radio, see page 18 for details.

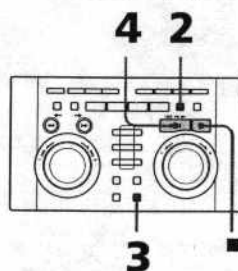

- 1** Insert a recordable MD (see page 18).  
You can record on any MDs inserted in MD 1 – 3 slots.  
**2** Press FUNCTION repeatedly to select the source (e.g., TAPE) you want to record.
  - TUNER: Recording from the radio
  - VIDEO/GAME: Recording from the component connected to the VIDEO/GAME IN jacks
  - TAPE: Recording from an optional tape deck
  - CD: Recording from a CD**3** Press REC/CD-MD SYNC.  
The MD deck stands by for recording.  
**4** Press ►||.  
Recording starts.  
**5** Start playing the source you want to record.

#### To stop recording

Press ■.

#### When recording is finished

Remove the MD. “TOC Write” flashes and the recorded contents are memorized on the MD.

#### While “TOC Write” is flashing

Do not move the unit or pull out the AC power cord to ensure complete recording. The deck updates the Table of Contents (TOC) while “TOC” is flashing.

#### Tip

Each time you press the DISPLAY button while recording, the display shows the recordable time and the remaining time alternately.

## Starting recording with 6 seconds of prestored audio data

### — Time Machine Recording

When recording from an FM or satellite broadcast, the first few seconds of material are often lost due to the time it takes you to ascertain the contents and press the record button. To prevent the loss of this material, the Time Machine Recording feature constantly stores 6 seconds of the most recent audio data in a buffer memory. When you start recording the sound source, the recording actually starts with the 6 seconds of audio data stored in the buffer memory in advance, as shown in the illustration below:

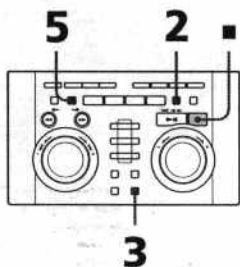
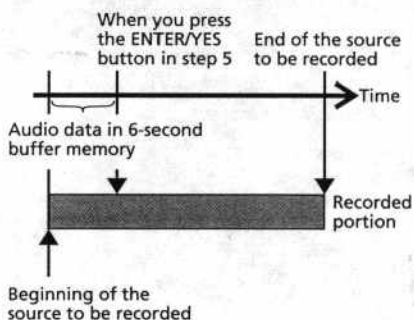

- 1** Insert a recordable MD.  
You can record on any MDs inserted in MD 1 – 3 slots.
- 2** Press FUNCTION repeatedly to select the source (e.g., TUNER) you want to record.
  - TUNER: Recording from the radio
  - VIDEO/GAME: Recording from the component connected to the VIDEO/GAME IN jacks
  - TAPE: Recording from an optional tape deck
- 3** Press REC/CD-MD SYNC.  
The MD deck stands by for recording.
- 4** Start playing the source you want to record.
- 5** Press ENTER/YES at the point you want to start recording.  
Recording of the source starts with the 6 seconds of audio data stored in the buffer memory.

**To cancel Time Machine Recording**  
Press ■.

### When recording is finished

Remove the MD. "TOC Write" flashes and the recorded contents are memorized on the MD.

### While "TOC Write" is flashing

Do not move the unit or pull out the AC power cord to ensure complete recording. The deck updates the Table of Contents (TOC) while "TOC" is flashing.

### Note

The MD deck starts storing audio data when the deck is in recording pause and you start playing the source. With less than 6 seconds of playing of the source and audio data stored in the buffer memory, Time Machine Recording starts with less than 6 seconds of audio data.

## Marking track numbers

You can mark track numbers using the following methods:

- Automatically during recording  
When you record from this system's CD (digital recording), the track numbers are automatically marked. When recording from other sources, you can mark track numbers automatically using the Level Synchro Recording function.
- At any point while recording  
You can mark track numbers while recording from any sources.

## Marking track numbers automatically while recording

### — Level Synchro Recording

Track numbers are automatically marked when the input signal continues to be under a certain level for more than two seconds and then exceeds the previous level.

This function is factory set to on. If "LEVEL-SYNCHRO" does not appear in the display during analog recording, set it to on following the procedure below.

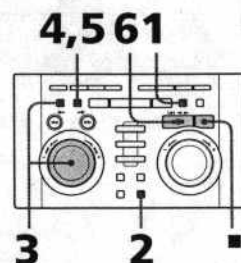

- 1** Press FUNCTION repeatedly to select "TUNER," "TAPE" or "VIDEO/GAME."
- 2** Press REC/CD-MD SYNC.  
The MD deck stands by for recording.
- 3** Press EDIT/NO, then turn MULTI JOG until "LEVELSync ?" appears.

- 4** Press ENTER/YES.  
"LEVELSync ON?" appears.
- 5** Press ENTER/YES again.  
"LEVEL-SYNCHRO" lights up.
- 6** Press ►||.  
Recording starts.

### To stop recording

Press ■.

### To cancel the track marking

- 1** In recording pause mode, press EDIT/NO, then turn MULTI JOG until "LevelSync ?" appears.
  - 2** Press ENTER/YES.  
"LevelSyncOFF?" appears.
  - 3** Press ENTER/YES again.  
"LEVEL-SYNCHRO" goes off.
- While "LEVEL-SYNCHRO" is not lit, a track number is marked only at the beginning of each recording.

### Note

You cannot mark track numbers automatically if the sound source to be recorded is noisy (e.g., tapes or radio programs).

## Marking track numbers at a specific point while recording

You can mark track numbers at any time while recording, regardless of the type of sound source, or type of connection.

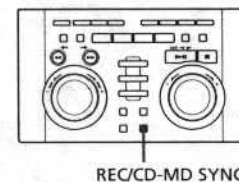

Press REC/CD-MD SYNC while recording at the point you want to add a track mark.

The tracks following the added one are renumbered.

## Making a space between tracks 3 seconds long

### — Smart Space/Auto Cut

The Smart Space and Auto Cut functions let you make a blank space between tracks three seconds long automatically while making a digital recording.

### Smart Space

If there is an extended silence of 3 to 30 seconds while digital recording, the MD deck replaces the silence with a blank of about 3 seconds and continues recording.

### Auto Cut

If there is no sound input for 30 seconds or more while digital recording, the MD deck replaces the silence of 30 seconds with a blank of about 3 seconds and changes to recording pause.

#### Tips

- The Smart Space and Auto Cut functions are factory set to on.
- If you turn the power off or disconnect the AC power cord, the MD deck will recall the last setting (on or off) of the Smart Space and Auto Cut functions the next time you turn the power on.

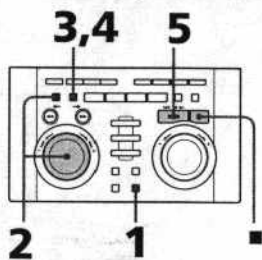

- 1 Press REC/CD-MD SYNC to stand by for recording.
- 2 Press EDIT/NO, then turn MULTI JOG until "S. Space ?" appears.

- 3 Press ENTER/YES  
"S. Space ON ?" appears.
- 4 Press ENTER/YES again.
- 5 Press ►||.  
Recording starts.  
When "Smart Space" appears during recording, the Smart Space function is activated. When "Auto Cut" appears, the Auto Cut function is activated.

### To stop recording

Press ■.

### To turn off the Smart Space and Auto Cut functions

- 1 While standing by for recording, press EDIT/NO repeatedly until "S. Space ?" appears.
- 2 Press ENTER/YES.  
"S. Space OFF ?" appears.
- 3 Press ENTER/YES again.

## The MD Deck – Editing

### Before you start editing

You can edit the recorded tracks on an MD. By using the editing functions, you can create original MD albums without copying the MD.

### Editing functions

#### • Name – Labeling MDs

Use this function to label MDs and tracks. You can use upper case, lower case, number and symbol for the titles.

#### • Erase – Erasing recordings

Use this function to erase unwanted tracks or portions.

#### • Move – Changing the order of tracks

Use this function to change the track numbering.

#### • Divide – Marking track numbers on recorded radio programs

Use this function to add track numbers. This lets you locate your favorite phrases quickly.

#### • Combine – Combining recorded tracks

By using this function, two tracks are combined to one track. You can combine the tracks which are not numerically consecutive, i.e. the track 1 and track 4, etc.

#### • Undo – Canceling the last edit

Use this function to cancel the last edit and restore the contents of the MD to the condition before the edit.

### Before editing

To edit MDs, the MD requires the following conditions:

- The MD is writable.
- The MD deck is in the Continuous mode.

Before editing, check the conditions by following the procedure below.

- 1 Make sure that the MD is not protected against erasure.  
If the MD is protected, you cannot edit the MD. Slide the tab to close the slot.

- 2 Press CONTINUE.  
You can edit MDs only in Continuous mode. You cannot edit MDs in Shuffle or Program mode.

### After editing

Press MD ▲ and pull the MD, or press POWER to turn off the system.

"TOC Write" starts flashing. The MD deck updates the TOC information of the MD and the editing is completed.

#### Note

Editing of an MD is completed when the TOC writing is finished. If you pull out the AC power cord before TOC writing is finished, the edited contents will not be memorized on the MD. TOC writing starts when you do any of the following operations. Be sure to do the following before pulling out the AC power cord.

- Eject the MD.
- Press POWER to turn off the system.

## Labeling an MD

### — Name Function

You can create titles (names) for your recorded MDs and tracks. About 1,700 characters can be memorized for each MD.

**4 5,10 2 6 3**

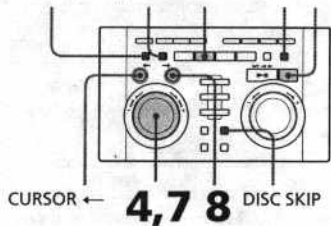

**1** Insert an MD you want to edit (see page 18).

**2** Press the MD button to switch the function to MD.

**3** Press ■ to stop playing. Make sure that the total number of tracks and the playing time appear in the display, then go to the next step. To label a track, turn MULTI JOG until the desired track number appears.

**4** Press EDIT/NO, then turn MULTI JOG until "MD Name in ?" appears.



**5** Press ENTER/YES. The cursor starts flashing.



**6** Press DISPLAY repeatedly until the type of character you want appears. Each time you press the button, the display changes as follows:

A (Upper case) → a (Lower case) → 0 (Numbers) → ! (Symbols)\* → ␣ (Space) → A...

\*You can use the following symbols.

! " # \$ % & ' ( ) \* + , - . / : ; < = > ? @ \_

**7** Turn MULTI JOG until the desired character appears. To enter a blank space, go to the next step without turning MULTI JOG. A blank space cannot be entered in the first position.

**8** Press CURSOR →. The character you selected in step 7 stops flashing and the cursor shifts to the right.

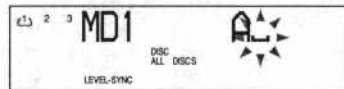

**9** Repeat steps 6 through 8 to complete the entire title. If you make a mistake, press CURSOR ← or → until the character you want to change flashes, then repeat steps 6 through 8. To erase a character, press EDIT/NO. Each time you press the button, the character in the cursor position is erased. You cannot insert a character between previously input characters.

**10** Press ENTER/YES to complete the labeling procedure. The titles you labeled appear sequentially and the display returns to the original indication after a while.

**To cancel labeling**  
Press ■.

### Checking the titles

To check the disc title, press DISC SKIP repeatedly to select the MD you want to check. To check the track title, turn MULTI JOG in stop mode until the track you want to check appears. The title scrolls in the display.

#### Notes

- You can check the titles by pressing the DISPLAY button. However, if the disc title exceeds 10 characters (or if the track title exceeds 7 characters), the characters after 10th (or 7th) do not appear.
- You can label a track title while playing, but you must complete labeling before the track ends.

### Erasing all titles

- In step 4 of "Labeling an MD," turn MULTI JOG until "Name AllErs?" appears, then press ENTER/YES. "Name AllErs??" appears.
- Press ENTER/YES. "MD Complete" appears and all the disc and track titles are erased.

**To cancel erasing**  
Press EDIT/NO.

### Erasing a disc title of an MD

- In step 4 of "Labeling an MD," turn MULTI JOG until "DiscNameErs?" appears, then press ENTER/YES. "DiscNameErs??" appears.
- Press ENTER/YES. The disc title is erased.

### Erasing a track title

- Turn MULTI JOG until the track number whose title you want to erase appears.
- Press EDIT/NO, turn MULTI JOG until "Name Ers?" appears, then press ENTER/YES. "Name Ers??" appears.
- Press ENTER/YES again. The track title you selected in step 1 is erased.

## Erasing recordings

### — Erase Function

The MD deck lets you erase unwanted tracks quickly and easily. The three options for erasing recordings are:

- Erasing a single track
- Erasing all tracks
- Erasing a portion of a track

You can restore the contents to the condition before erasing (unerase) by using the Undo function. However, check carefully the portion to be erased, as you cannot undo an edit after doing another editing operation.

### Erasing a single track

You can erase a track simply by selecting its track number. When you erase a track, the total number of tracks on the MD decreases by one and all the tracks following the erased one are renumbered.

E.g.: Erasing track 2

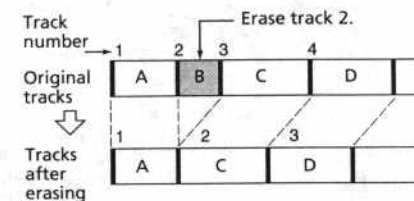

When erasing multiple tracks, you should proceed in order from high to low track number to prevent the renumbering of tracks that have not been erased yet.

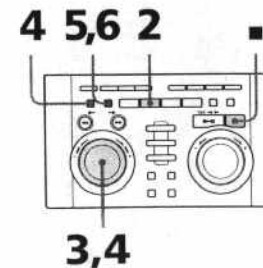

continued 47



## Erasing recordings (continued)

- 1 Insert an MD you want to edit (see page 18).
- 2 Press the MD button to switch the function to MD.
- 3 Turn MULTI JOG until the track number you want to erase appears.

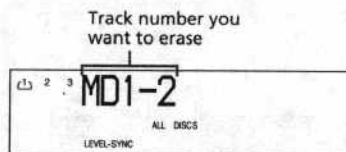

- 4 Press EDIT/NO, then turn MULTI JOG until "Erase ?" appears.
- 5 Press ENTER/YES. "Erase ???" appears. To cancel erasing, press ■.
- 6 Press ENTER/YES again to erase the track. "MD Complete" appears for a few seconds and the selected track and title are erased.

### To cancel the Erase Function

Press ■.

### Note

"Erase!! ?" appears when the track was recorded or edited on another deck and is erase protected. To erase the track, press ENTER/YES while "Erase!! ?" appears.

## Erasing all tracks

You can erase the disc title, all recorded tracks and their titles at once.

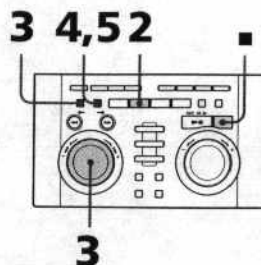

- 1 Insert an MD you want to edit (see page 18).
- 2 Press the MD button to switch the function to MD.
- 3 While the deck is stopped, press EDIT/NO, then turn MULTI JOG until "MD All Erase?" appears.
- 4 Press ENTER/YES. "MD AllErase??" appears.
- 5 Press ENTER/YES again. "MD Complete" appears for a few seconds and the disc title, all recorded tracks and their titles are erased.

### To cancel the Erase Function

Press ■.

## Erasing a portion of a track

By using the Divide (see page 50), Erase (see page 47), and Combine (see page 51) Functions, you can erase specific portions of a track.

E.g.: Erasing a portion of track A

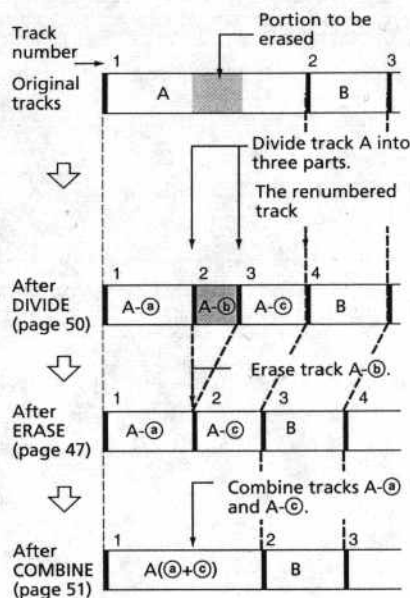

## Moving recorded tracks

### — Move Function

Using the Move Function, you can change the order of any track on the MD. When you move tracks, the tracks are automatically renumbered.

E.g.: Moving track 3 to track 2

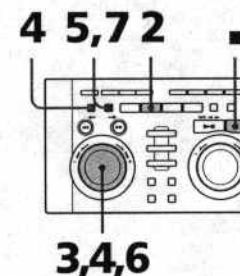
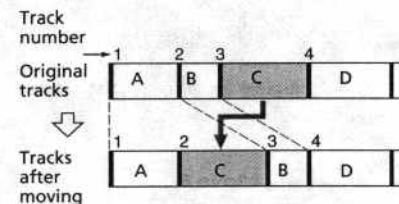

- 1 Insert an MD you want to edit (see page 18).
- 2 Press the MD button to switch the function to MD.
- 3 Turn MULTI JOG until the track number you want to move appears.
- 4 Press EDIT/NO, then turn MULTI JOG until "Move ?" appears.
- 5 Press ENTER/YES.

## Moving recorded tracks (continued)

- Turn MULTI JOG until the track number you want to move the track to (new track number) appears.

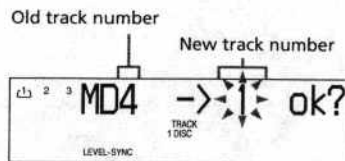

- Press ENTER/YES. "MD Complete" appears for a few seconds and the track is moved.

### To cancel the Move Function

Press ■.

## Dividing recorded tracks

### — Divide Function

You can use this function to add track numbers to multiple tracks that are recorded as one track. This function also lets you mark track numbers after finishing recording. The total number of tracks increases by one and all the tracks following the new division are renumbered.

E.g.: Dividing track 2 into two tracks

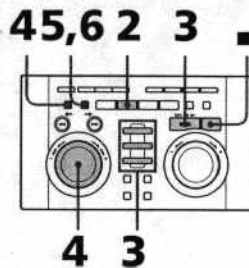
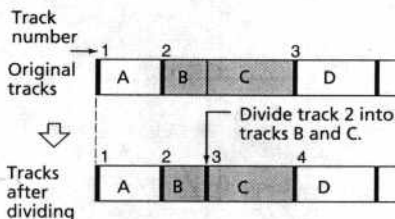

- Insert an MD you want to edit (see page 18).
- Press the MD button to switch the function to MD.
- While playing the MD, press ►|| when you find the point to be divided. The MD deck pauses.

- Press EDIT/NO, then turn MULTI JOG until "Divide ?" appears.

- Press ENTER/YES. "MD Rehearsal" and "MD Position ok?" appear alternately and the portion to be divided is played repeatedly.

### To shift the division point:

While monitoring the sound, turn MULTI JOG to find the division point. The point moves in increments of 1/86 second (1 frame).

- Press ENTER/YES. "MD Complete" appears for a few seconds and the newly created track begins playing.

### To cancel the Divide Function

Press ■.

### Notes

- If you divide a labeled track (page 46) into two tracks, only the first track is labeled with the title.

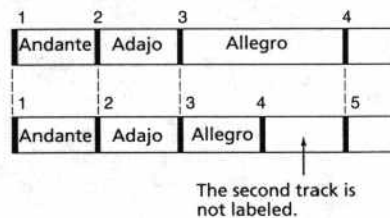

- "Impossible" appears when you specify the division point at the beginning or ending of a track. Shift the division point by turning the MULTI JOG.

## Combining recorded tracks

### — Combine Function

You can combine several tracks or several independently recorded portions into a single track. The total number of tracks decreases by one and the tracks are automatically renumbered.

E.g.:

- Combining track 3 to the end of track 1

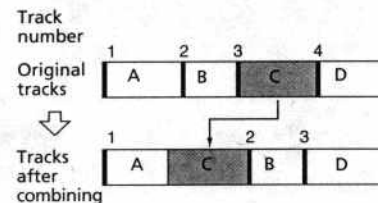

- Combining track 1 to the end of track 4

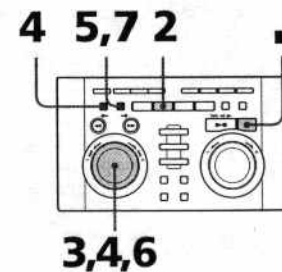
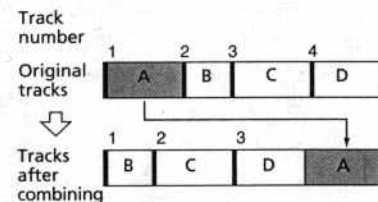

- Insert an MD you want to edit (see page 18).

### Combining recorded tracks (continued)

**2** Press the MD button to switch the function to MD.

**3** Turn MULTI JOG until the first track of the two to be combined appears.

For example, to combine track 1 to the end of track 4, select track 4.

**4** Press EDIT/NO, then turn MULTI JOG until "Combine ?" appears.

**5** Press ENTER/YES.

First track of the two to be combined



**6** Turn MULTI JOG until the second track of the two to be combined appears.

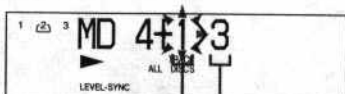

Second track of the two to be combined      New track number

**7** Press ENTER/YES.  
"MD Complete" appears for a few seconds and the tracks are combined. The combined track starts playing.

### To cancel the Combine Function

Press ■.

### Notes

- If both of the combined tracks have track titles, the title of the second track is erased.
- If "Impossible" appears, the tracks cannot be combined. This happens when you have edited the same track too many times. This is due to a technical limitation of the MD system and is not a mechanical error.

## Undoing the last edit

### — Undo Function

This function lets you cancel the last edit and restore the contents of the MD to the condition before the edit.

Note, however, that you cannot undo an edit if you do any of the following after the edit:

- Do any other editing operation.
- Press REC/CD-MD SYNC.
- Press REC IT.
- Turn off the system or eject the MD.
- Disconnect the AC power cord.

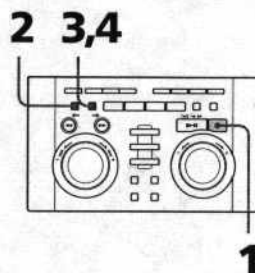

**1** Press ■.

Make sure that the total number of tracks and the playing time appear in the display, then go to the next step.

**2** Press EDIT/NO, then turn MULTI JOG until "Undo ?" appears.

**3** Press ENTER/YES.

One of the following messages appears, depending on the last edit.

| Editing done:               | Message:        |
|-----------------------------|-----------------|
| Labeling a track or an MD   | "Name Undo?"    |
| Erasing all titles on an MD |                 |
| Erasing a single track      | "Erase Undo?"   |
| Erasing all tracks on an MD |                 |
| Moving a track              | "Move Undo?"    |
| Dividing a track            | "Divide Undo?"  |
| Combining tracks            | "Combine Undo?" |

**4** Press ENTER/YES again.

"MD Complete" appears for a few seconds and the contents of the MD are restored to the condition before the edit.

## Sound Adjustment

### Adjusting the sound

You can listen to music with stronger bass or a more powerful sound.

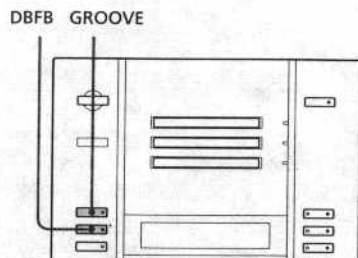

### Reinforcing the bass sound

Press DBFB (Dynamic Bass Feedback). The indicator on the button lights up. Each time you press the button, the display changes as follows:

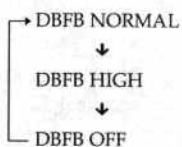

### Getting a more powerful sound

Press GROOVE.

The indicators on the GROOVE and DBFB buttons light up.

The volume increases and the bass sound is reinforced.

Press the button again to cancel GROOVE. DBFB is also canceled.

#### Tip

The DBFB function is factory set to on.

### Selecting the Preset Equalizer menu

The Preset Equalizer enables you to select the sound characteristic from among 15 sound effects according to the music you are listening to.



- 1 Press PRESET EQ.
- 2 Turn MULTI JOG until the effect you want appears.
- 3 Press ENTER/YES.

#### To cancel the Preset Equalizer

Press EDIT/NO in step 2.

#### Tips

- The Preset Equalizer menu is factory set to "1 ROCK."
- The Preset Equalizer effect is not recorded on an MD or a tape.

## Other Features

### Labeling the preset stations

#### — Station Name

You can label each preset station with up to 8 characters (Station Name). The Station Name appears when you tune in the station.

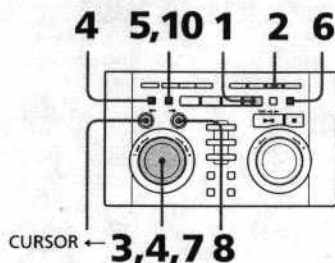

- 1 Press TUNER repeatedly until the band you want appears.

#### North American model:

FM → AM

#### European model:

FM → MW → LW

#### Other models:

FM → MW → SW

- 2 Press PRESET.
- 3 Turn MULTI JOG until the preset number of the station you want to label appears.
- 4 Press EDIT/NO, then turn MULTI JOG until "TUNER Name in?" appears.



- 5 Press ENTER/YES. The cursor starts flashing.

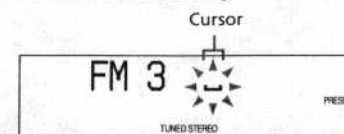

- 6 Press DISPLAY repeatedly until the type of character you want appears. Each time you press the button, the display changes as follows:

A (Upper case) → a (Lower case) → 0  
 (Numbers) → ! (Symbols)\* → (Space)  
 → A...

\*You can use the following symbols.

!"#\$%&'()\*+,-./:;<=>?@\_`

- 7 Turn MULTI JOG until the desired character appears. The selected character flashes. To enter a blank space, go to the next step without turning MULTI JOG. A blank space cannot be entered in the first position.

- 8 Press CURSOR →. The character you selected in step 7 stops flashing and the cursor shifts to the right.

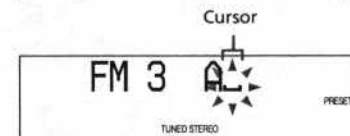

continued

### Labeling the preset stations (continued)

- 9** Repeat steps 6 through 8 to complete the name.  
If you make a mistake, press CURSOR ← or → until the character you want to change flashes, then repeat steps 6 through 8. To erase a character, press EDIT/NO. Each time you press the button, the character in the cursor position is erased. You cannot insert a character between previously input characters.

- 10** Press ENTER/YES to complete the labeling procedure.  
The Station Name is stored in the system's memory.

#### To cancel labeling

Press PRESET.

#### To check the name while tuning

Press DISPLAY.

Each time you press the button, the display changes as follows:

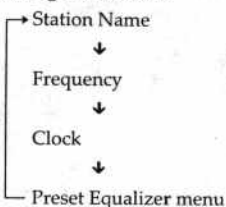

#### To erase the name

Repeat steps 1 through 5, then press EDIT/NO repeatedly until all the letters are erased.

## Using the Radio Data System (RDS) (European model only)

### (European model only)

#### What is the Radio Data System?

Radio Data System (RDS) is a broadcasting service that allows radio stations to send additional information along with the regular program signal. This tuner offers a convenient RDS feature, locating a station by program type (PTY). RDS is available only on FM stations\*.

#### Note

RDS may not work properly if the station you are tuned to is not transmitting the RDS signal properly or if the signal strength is weak.

\* Not all FM stations provide RDS service, nor do they provide the same types of services. If you are not familiar with the RDS system, check with your local radio stations for details on RDS services in your area.

#### Receiving RDS broadcasts

Simply select a station from the FM band.

When you tune in a station that provides RDS services, the station name appears in the display.

#### To check the RDS information

Each time you press DISPLAY, the display changes as follows:

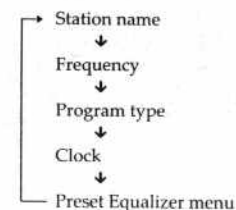

## Locating a station by program type (PTY)

You can locate a station you want by selecting a program type. The system tunes in the type of programs currently being broadcast from the RDS stations stored in the tuner's preset memory.

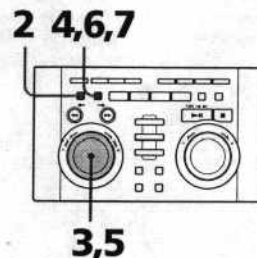

- 1** Tune in an RDS station.
- 2** Press EDIT/NO.
- 3** Turn MULTI JOG until "PTY Search?" appears.
- 4** Press ENTER/YES.
- 5** Turn MULTI JOG until the desired program type appears.  
See "List of program types (PTY)."
- 6** Press ENTER/YES.  
The system starts searching for the preset RDS stations ("Search" and the selected program type appear alternately).  
When the tuner receives a program, the preset station number flashes.
- 7** Press ENTER/YES if the tuner receives the desired program.

#### To select another station from the desired program type

In step 7, turn MULTI JOG and start over from step 5.

#### To cancel PTY Search

Press EDIT/NO. The system tunes in the station you were listening to.

#### List of program types (PTY)

##### NEWS

News programs.

##### AFFAIRS

Topical programs that expand on current news.

##### INFORMATION

Programs about consumer affairs, medical advice, and weather.

##### SPORT

Sports programs.

##### EDUCATION

Educational programs, such as a "how-to" programs and advice.

##### DRAMA

Radio plays and serials.

##### CULTURE

Programs about national or regional culture, such as religion, language, and societal concerns.

##### SCIENCE

Programs about the natural sciences.

##### VARIED

Programs containing celebrity interviews, panel games, and comedy.

##### POP MUSIC

Popular music programs.

##### ROCK MUSIC

Rock music programs.

##### M.O.R. MUSIC

Easy listening (middle of the road music).

##### L. CLASSICAL

Classical music, such as instrumentals, and vocal and choral works.

## Using the Radio Data System (RDS) (continued)

### S. CLASSICAL

Performances of major orchestras, chamber music, opera, etc.

### OTHER MUSIC

Music, such as jazz, rhythm and blues, and reggae.

### ALARM

Emergency broadcasts.

### NONE

Any programming not defined above.

### Note

"No PTY" appears when the program you selected is not currently being broadcast.

## Falling asleep to music

### — Sleep Timer

You can set the system to turn off after a certain time without setting the clock, so you can fall asleep to music. You can set the timer in 10 minute increments.

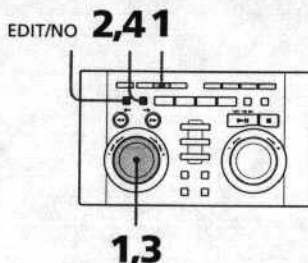

- 1 Press **CLOCK/TIMER SET**, then turn **MULTI JOG** until "SET SLEEP ?" appears.

- 2 Press **ENTER/YES**.

- 3 Turn **MULTI JOG** to select the desired time.  
As you turn **MULTI JOG**, the minute display (the time after which the system turns off) changes as follows:

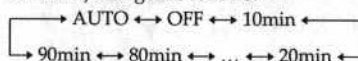

- 4 Press **ENTER/YES**.

### To check the remaining time

Repeat steps 1 and 2, then press **EDIT/NO**.

### To change the turn off time

Start over from step 1.

### To cancel the Sleep Timer function

In step 3, select "SLEEP OFF."

### When you choose AUTO

The system turns off when the current CD or MD finishes playback. The system turns off if you manually stop playing a CD or MD by pressing ■.

## Waking up to music

### — Daily Timer

You can wake up to music at a preset time every day. Make sure you have set the clock (see page 5).

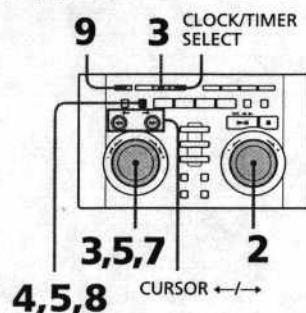

- 1 Prepare the music source you want to play.

- CD: Insert a CD. To start from a specific track, make a program (see page 21).
- MD: Insert an MD. To start from a specific track, make a program (see page 30).
- Radio: Tune in a station (see page 17).
- Tape: Insert a tape into the optional TC-TX515 deck.

- 2 Turn **VOLUME** to adjust the sound volume.

- 3 Press **CLOCK/TIMER SET**, then turn **MULTI JOG** until "SET DAILY ?" appears.

- 4 Press **ENTER/YES**.  
The hour indication flashes.

- 5 Set the time to start play.  
Turn **MULTI JOG** to set the hour, then press **ENTER/YES**.  
The minute indication flashes.

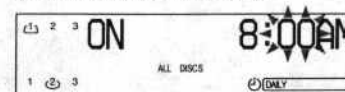

Turn **MULTI JOG** to set the minute, then press **ENTER/YES**.  
The hour indication flashes again.

- 6 Set the time to stop playback following the procedure in step 5.

- 7 Turn **MULTI JOG** to select the desired music source.  
As you turn **MULTI JOG**, the display changes as follows:

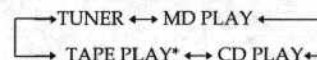

\* Select this when recording from an optional component connected to the TAPE IN jacks.

- 8 Press **ENTER/YES**.  
The start time, followed by the stop time and the sound source appears, then the original display appears.
- 9 Press **POWER** to turn off the system.

### To change the setting

Start over from step 1. After step 5, press **CURSOR ←** or **→** until the setting you want to change flashes and change it.

### To check the setting or turn on the timer

- 1 Press **CLOCK/TIMER SELECT**, then turn **MULTI JOG** until "SELECT DAILY ?" appears.
- 2 Press **ENTER/YES**.  
The start time, followed by the stop time and the music source appears, then the original display appears.

## Waking up to music (continued)

### To cancel the timer

- 1 Press CLOCK/TIMER SELECT, then turn MULTI JOG until "TIMER OFF ?" appears.
  - 2 Press ENTER/YES.
- "DAILY" disappears from the display and the timer is canceled.

### Tip

When you connect the optional TC-TX515 deck to the system, you can activate the deck using the Daily Timer function without setting the timer on the deck.

### Notes

- You cannot activate the Daily Timer and Timer-recording at the same time.
- The system turns on about 30 seconds before the preset time. Do not operate the system from the time the power turns on until the playback starts.
- If the power is on at the preset time, the music source you set starts playing.
- If you use an audio/video component other than the optional TC-TX515 deck as the music source, set the timer also on the audio/video component.

## Timer recording radio programs

You can make up to three settings of start and stop time, and turn on those settings at the same time. You can record a long program on up to three MDs sequentially. To timer record, you must first preset the radio station (see page 6) and set the clock (see page 5).

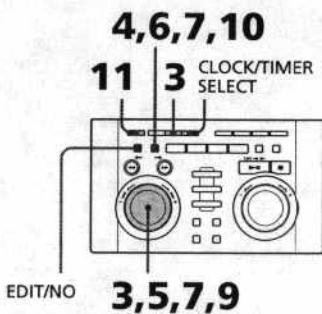

- 1 Insert a recordable MD.  
You can record on any MDs in the MD 1 - 3 slots. When you want to record a long program, insert two or three MDs according to the program length. Recording starts from the MD 1.
- 2 Tune in the preset radio station (see page 17).
- 3 Press CLOCK/TIMER SET, then turn MULTI JOG until "SET REC ?" appears.



- 4 Press ENTER/YES.

- 5 Turn MULTI JOG until the timer number ("SET REC 1 ?" - "SET REC 3 ?") appears.



- 6 Press ENTER/YES.  
The day of the week indication flashes.  
"SUN" - "SAT": Select this to timer record with the same setting on the same day every week.  
"ALL": Select this to timer record with the same setting every day.



- 7 Set the time to start recording.  
Turn MULTI JOG to set the day of the week, then press ENTER/YES.  
The hour indication flashes.

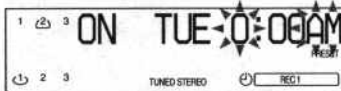

Turn MULTI JOG to set the hour, then press ENTER/YES.  
The minute indication flashes.



Turn MULTI JOG to set the minute, then press ENTER/YES.  
The day of the week indication flashes again.

- 8 Set the time to stop recording following the procedure in step 7.

- 9 Turn MULTI JOG to select the MD you want to record on.

As you turn the MULTI JOG, the display changes as follows:

MD 1 ↔ MD 2 ↔ MD 3 ↔ MDALL  
↑ TAPE\* ↓

When you want to record on two or three MDs sequentially, select "MDALL."

\* When recording on a tape of the optional TC-TX515 deck, select "TAPE."

- 10 Press ENTER/YES.

The timer number, followed by the start time, the stop time, music source and the recording component appears, then the original display appears.

- 11 Press POWER to turn off the system.

### To change the setting

Start over from step 1.

If you make a mistake, press EDIT/NO repeatedly to go back to the setting you want to change, then set it again.

### To turn on or off the timer

- 1 Press CLOCK/TIMER SELECT, turn MULTI JOG until "SELECT REC ?" appears, then press ENTER/YES.  
The timer number in which you have stored a setting (REC 1 - 3) appears.
- 2 Turn MULTI JOG to select "ON" or "OFF," then press ENTER/YES.  
Each time you press the ENTER/YES button, the timer numbers in which you have stored the settings appear in order. Turn on or off each timer setting.  
The display shows the timer numbers and their settings you turned on, then returns to the original indication.

## Timer recording radio programs (continued)

### To check the timer

Follow the procedure in "To turn on or off the timer" (see page 61). Select the timer number you want to check in step 1 and select "ON" in step 2. The setting appears at the end of the procedure.

### When the setting time is overlapped

The time indicated with  cannot be recorded.

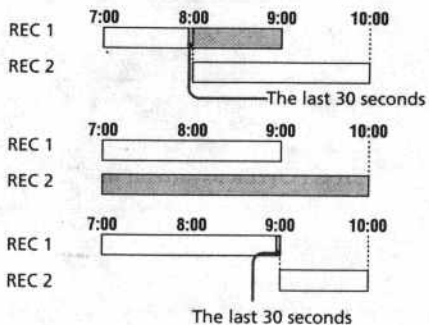

### Tip

The MD is automatically labeled with the Station Name (or frequency if the station is not labeled), the start time and the stop time of the recording (see page 55).

### Notes

- If you select "MDALL" in step 9 to record a long program and the MD in the MD 1 slot becomes full, the rest of the program is automatically recorded on the MD in the next slot. If no other MDs are inserted, insert another recordable MD in the next slot and remove the MD you do not want to record on beforehand. The program will not be recorded while the MDs are being exchanged.
- Do not operate the system from the time the power turns on until the recording starts (about 30 seconds).
- If the start time and stop time are the same, the cursor goes back to the stop time. Change the stop time.
- When you record on a blank MD, the first 30 seconds are not recorded.
- If the power is on at 30 seconds before the preset time, the recording will not be made.
- The volume is reduced to minimum during recording.

## Additional Information

### Precautions

#### On operating voltage

Before operating the system, check that the operating voltage of your system is identical with the voltage of your local power supply.

#### On safety

- The system is not disconnected from the AC power source (mains) as long as it is connected to the wall outlet, even if the system itself has been turned off.
- Unplug the system from the wall outlet if it is not to be used for an extended period of time. To disconnect the AC power cord, pull it out by the plug. Never pull the cord itself.
- Should any solid object or liquid fall into the system, unplug the system and have it checked by qualified personnel before operating it any further.
- The AC power cord must be changed only at a qualified service shop.

#### On placement

- Place the system in a location with adequate ventilation to prevent heat build up.
- Do not place the system in an inclined position.
- Do not place the system in locations where it is;
  - Extremely hot or cold
  - Dusty or dirty
  - Very humid
  - Subject to vibrations
  - Subject to direct sunlight.
- The system has a radiator at the rear panel to prevent heat build up. To increase the efficiency of the radiator, place the system in a location with sufficient air space in the rear and do not put anything on top.

#### On operation

If the system is brought directly from a cold to a warm location, or is placed in a very damp room, moisture may condense on the lens inside the CD player or the MD deck. Should this occur, the system will not operate properly. Remove the CD and leave the system turned on for about an hour until the moisture evaporates.

#### On transportation

- When you move the system, remove all the CDs and MDs, and turn off the system.
- After turning off the system and making sure the system stops completely, insert the transport MD cartridge into the MD 3 slot with the arrow-printed side up. If you transport the system without the cartridge inserted, it may damage the MD deck.

If you have any questions or problems concerning your system, please consult your nearest Sony dealer.

#### On the speaker system

Although this speaker system is magnetically shielded, there may be cases where the picture on some TV sets becomes magnetically distorted. In such a case, turn off the power of the TV set once, and after 15 to 30 minutes turn it on again.

**If there seems to be no improvement**, locate the speaker system further away from the TV set. Also, be sure not to place objects in which magnets are attached or used near the TV set, such as audio racks, TV stands and toys. These may cause magnetic distortion to the picture due to their interaction with the system.

#### Notes on MDs

- Do not open the shutter to expose the MD. Close the shutter immediately if the shutter opens.



- Wipe the disc cartridge with a dry cloth to remove dirt.
- Do not expose the MD to direct sunlight or heat sources such as hot air ducts, nor leave it in a car parked in direct sunlight.

#### Notes on CDs

- Before playing, clean the CD with a cleaning cloth. Wipe the CD from the center out.
- Do not use a CD with tape, seals, or paste on it as this may damage the player.
- Do not use solvents such as benzine, thinner, commercially available cleaners or anti-static spray intended for vinyl LPs.
- Do not expose the CD to direct sunlight or heat sources such as hot air ducts, nor leave it in a car parked in direct sunlight.

#### Cleaning the cabinet

Use a soft cloth slightly moistened with mild detergent solution.



## System limitations of MDs

The recording system in your MD deck has the limitations described below. Note, however, that these limitations are due to the inherent nature of the MD recording system itself, not to mechanical causes.

### "Disc Full" lights up before the MD has reached the maximum recording time (60 or 74 minutes)

When 255 tracks have been recorded on the MD, "Disc Full" lights up regardless of the total recorded time. More than 255 tracks cannot be recorded on the MD. To continue recording, erase unnecessary tracks or use another recordable MD.

### "Disc Full" lights up before the maximum number of tracks (255) is reached

Fluctuations in emphasis within tracks are sometimes interpreted as track intervals, increasing the track count and causing "Disc Full" to light up.

### The remaining recording time does not increase even after erasing numerous short tracks

Tracks shorter than 12 seconds are not counted, so erasing them may not increase the recording time.

### Some tracks cannot be combined with others

Track combination may become impossible when tracks are shorter than 12 seconds.

### The total recorded time and the remaining time on the MD do not add up to the maximum recording time (60 or 74 minutes)

Recording is done in minimum units of 2 seconds each, no matter how short the material. The recorded contents may be shorter than the maximum recording capacity. Disc space may also be reduced by scratches.

### The sound may drop-out while searching the edited tracks

Tracks created through editing may exhibit sound dropout during searching because high-speed playback requires time to search for the position on the disc when the tracks are not in order.

### Track numbers cannot be marked

When "LevelSync ON" (page 43) is displayed during analog recording, the track numbers may not be marked at the beginning of the track:

- if the input signal is below a certain fixed level for less than two seconds between tracks.
- if the input signal is below a certain fixed level for more than two seconds in the middle of the track.

### Guide to the Serial Copy Management System

Digital audio components, such as CDs, MDs, and DATs let you copy music easily with high quality, for these digital products process music as a digital signal.

To protect the copyrighted music programs, this system uses the Serial Copy Management System that allows you to make only a single copy of a digitally recorded source through digital-to-digital connections.

**You can make only a first generation copy\* through a digital-to-digital connection.**

For example:

- 1 You can make a copy of a commercially available digital sound program (for example, a CD or MD), but you cannot make a second copy from the first-generation copy.
  - 2 You can make a copy of a digital signal from a digitally recorded analog sound program (for example, an analog record or a music cassette tape) or from a digital satellite broadcast program, but you cannot make a second copy.
- \* A first-generation copy means a digital recording of a digital signal made on digital audio equipment. For example, if you record from this system's CD player to the MD deck, you make a first-generation copy.

### Notes

- This copy management system doesn't apply when you make a recording through analog-to-analog connections.
- This system's MD deck supports 32 kHz or 48 kHz sampling frequency of the DAT deck or digital satellite broadcast programs as well as 44.1 kHz sampling rate of the MD deck. You can make a second copy from a digital recording of the satellite broadcast program.

## Using the Self-Diagnostic Display

This system has the Self-Diagnostic function to let you know if there is a system malfunction. The display shows a code made up of three letters and a message alternately to show you the problem. To solve the problem, refer to the following list. If any problem persists, consult your nearest Sony dealer.

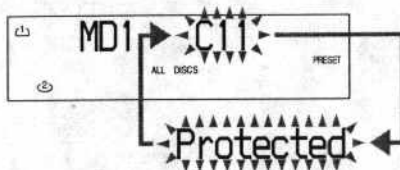

### C11/MD Protected

The MD is protected against erasure.

- Remove the MD and slide the tab to close the slot (page 33)

### C13/REC Error

Recording is not possible.

- Move the system to a stable place and start recording over from the beginning. The MD is dirty or is scratched. / The MD does not meet the standards.
- Change the MD with another one and start recording over from the beginning.

### C13/Disc Error

The MD deck cannot read the disc information correctly.

- Eject the MD once, then insert it again.

### C14/Disc Error

The MD deck cannot read the disc information correctly.

- Change the MD with another one.
- If you don't mind erasing all the recorded contents of the MD, erase them using the Erase function on page 48.

## Troubleshooting

If you have any problem using this system, use the following checklist.

First, check that the AC power cord is connected firmly and the speakers are connected correctly and firmly.

Should any problem persist, consult your nearest Sony dealer.

### General

#### There is no sound.

- Turn VOLUME clockwise.
- The headphones are connected.
- Connect the cords and cables properly. Insert the plugs firmly.

#### There is severe hum or noise.

- A TV or VCR is placed too close to the system. Move the system away from the TV or VCR.

#### "0:00" (for European model) or "12:00 AM" (for other models) flashes in the display.

- A power interruption occurred. Set the clock and timer settings again.

#### The timer does not function.

- Set the clock correctly.

#### The detachable controller does not function.

- There is an obstacle between the detachable controller and the system.
- The detachable controller is not pointing in the direction of the system's sensor.
- The batteries have run down. Replace the batteries.

#### There is acoustic feedback.

- Decrease the volume level. Move the microphone away from the speakers or change the direction of the microphone.

#### The display is dimmed.

- You changed the brightness of the display. Press DIMMER repeatedly to adjust the brightness.

## Troubleshooting (continued)

### A code made up of three letters and message flash alternately.

- The Self-Diagnostic function is working. Solve the problem referring to the check list (page 65).

## Speakers

### Sound comes from one channel or the left and right volume are unbalanced.

- Check the speaker connections and speaker placement.

## CD Player

### The CD tray does not close.

- The CD is not placed properly.

### The CD will not eject.

- The CD has tape, seals, or paste on it.

### The CD will not play.

- The CD is dirty.
- The CD is inserted label side down.
- Moisture condensation has built up. Remove the CD and leave the system turned on for about an hour until the moisture evaporates.

### Play does not start from the first track.

- The player is in program or shuffle mode. Press CONTINUE.

### "OVER" is displayed.

- You have reached the end of the CD. Press ◀ or turn MULTI JOG to return to the beginning of the CD.

### The CD indicator lights up when no CDs are inserted in the disc tray.

- The CD indicator lights up when you turn on the system for the first time. It will go off after a while.
- Last time you used the system, you turned it off with the disc tray opened. It will go off after a while. If not, press CD ▲ several times to open and close the disc tray.

## MD Deck

### An partially inserted MD cannot be pulled out.

- The MD deck's self-lock system has gripped the MD. Insert the MD completely, then press MD ▲.

### An MD cannot be inserted.

- Insert the MD with the label side up in the direction of the arrow.

### The controls do not work.

- The MD is dirty or scratched. ("Disc Error" appears.) Replace the MD with a new one.

### The MD will not play.

- Moisture condensation has built up. Remove the MD and leave the system turned on for several hours until the moisture evaporates.
- Insert the MD in the direction of the arrow.
- Nothing is recorded on the MD.

### Recording is not possible.

- The MD is protected against erasure. ("MD Protected" appears.) Slide the tab to close the slot (see page 33).
- Connect the sound source properly.
- A pre-recorded MD is in the deck. Replace the disc with a recordable MD.
- Replace the disc with a recordable MD that has sufficient time remaining or erase unnecessary tracks.
- The AC power cord was unplugged or a power interruption occurred during recording. Start recording over from the beginning.

### Recording cannot be made on all MDs during CD-MD Synchro Recording

- Either CD or MD is not inserted in the same disc number.

### "OVER" is displayed.

- You have reached the end of the MD. Press ◀ or turn MULTI JOG to return to the beginning of the MD.

## Tuner

### Severe hum or noise ("TUNED" or "STEREO" flashes in the display).

- Adjust the antenna.
- The signal strength is too weak. Connect an external antenna.

### A stereo FM program is not received in stereo.

- Press STEREO/MONO so "STEREO" appears.

## Messages

One of the following messages may appear or flash in the display during MD operation.

### MD

#### Auto Cut

The MD deck is pausing the recording because silence continued for 30 seconds or more during digital recording.

#### Blank Disc

The inserted recordable MD is brand-new or all tracks on the MD have been erased.

#### Cannot Copy

You cannot make a digital recording (see "Guide to the Serial Copy Management System" on page 64).

#### Can't EDIT

A pre-recorded MD is in the deck. You tried to edit in Program or Shuffle Play mode.

#### Cannot REC

A pre-recorded MD is in the deck.

#### Complete

The editing operation of MDs is completed.

#### Disc Full

There is no time remaining on the disc (see "System limitations of MDs on page 64).

#### Impossible

You tried to make an impossible editing operation (see page 51).  
You tried to combine a track, which is not possible due to a technical limitation of MD system (see page 52).

#### MECHA ERROR

The transport MD cartridge is inserted.

#### Name Full

There is no more space to store track or disc titles.

#### NEW

The deck stands by for recording on a brand-new MD or from the end of the recorded portion.

#### NO DISC

There is no MD in the deck.

## Troubleshooting (continued)

### No Name

The selected MD or track is not labeled.

### No Track

The inserted MD has a disc title but no tracks.

### OVER

You have reached the end of the last track during high-speed search.

### Position ok?

The MD is playing the division point during Divide Function.

### Push STOP!

You pressed a play mode button (CONTINUE, SHUFFLE or PROGRAM) during play.

### Rehearsal

The MD is playing to check the selected division point during Divide Function.

### Release

The deck is ejecting an MD.

### Smart Space

The signal was input again after silence continued for 30 seconds or less during digital recording.

### TOC Read

The MD deck is reading the TOC information of the MD.

### TOC Write

The MD deck is writing the information of recorded or edited contents.

## TUNER

### Name Full

You have already input the maximum number of characters for a Station Name (8 characters).

## CD

### File Full

The system has already stored the maximum number of Disc Memos (100 Disc Memos).

### - OVER -

You have reached the end of the CD while pressing the ►► button during pause.

## Specifications

### Amplifier section

#### For the U.S. model

### AUDIO POWER SPECIFICATIONS

#### POWER OUTPUT AND TOTAL HARMONIC DISTORTION:

With 6 ohm loads, both channels driven, from 70 - 20,000 Hz; rated 25 watts per channel minimum RMS power, with no more than 0.9% total harmonic distortion from 250 milliwatts to rated output.

Continuous RMS power output (Reference)  
35 + 35 watts  
(6 ohms at 1 kHz, 10% THD, 120V) (Reference)

#### European model:

DIN power output (Rated)  
30 + 30 watts  
(6 ohms at 1 kHz, DIN, 230 V)

Continuous RMS power output (Reference)  
40 + 40 watts  
(6 ohms at 1 kHz, 10% THD)

Music power output (Reference)  
60 + 60 watts

#### Other models:

DIN Power output (Rated)  
30 + 30 watts (60 ohms at 1 kHz, DIN, 120 / 240 V)

Continuous RMS power output (Reference)  
40 + 40 watts  
(6 ohms at 1 kHz, 10% THD)

Peak music power output (Reference)  
700 watts

#### Inputs

VIDEO / GAME IN (phono jacks) (switchable)  
GAME IN: voltage 450 mV, impedance 47 kilohms  
VIDEO IN: voltage 250 mV, impedance 47 kilohms  
TAPE IN (phono jacks): voltage 250 mV, impedance 47 kilohms

#### Outputs

TAPE OUT (phono jacks): voltage 250 mV, impedance 1 kilohm

#### PHONES (stereo mini jack):

accepts headphones of 8 ohms or more.  
accepts impedance of 6 to 16 ohms.

#### SPEAKER:

### CD player section

|                    |   |
|--------------------|---|
| System             | Compact disc and digital audio system   |
| Laser              | Semiconductor laser ( $\lambda=780$ nm)<br>Emission duration: continuous  |
| Laser output       | Max. 44.6 $\mu$ W*<br>*This output is the value measured at a distance of 200 mm from the objective lens surface on the Optical Pick-up Block with a 7 mm aperture. |
| Frequency response | 2 Hz - 20 kHz   |

### MD deck section

|                    |   |
|--------------------|---|
| System             | MiniDisc digital audio system   |
| Laser              | Semiconductor laser ( $\lambda=780$ nm)<br>Emission duration: continuous  |
| Laser output       | Max. 44.6 $\mu$ W*<br>*This output is the value measured at a distance of 200 mm from the objective lens surface on the Optical Pick-up Block with a 7 mm aperture. |
| Recording time     | 74 minutes max. (using MDW-74)  |
| Sampling frequency | 44.1 kHz  |
| Frequency response | 5 Hz to 20 kHz  |

### Tuner section

FM stereo, FM / AM superheterodyne tuner

### FM tuner section

|                        |                                |
|------------------------|--------------------------------|
| Tuning range           | 76.0 - 108.0 MHz               |
| Tourist model:         | (50 kHz step)                  |
| Other models:          | 87.5 - 108.0 MHz (50 kHz step) |
| Antenna                | FM lead antenna                |
| Antenna terminals      | 75 ohm unbalanced              |
| Intermediate frequency | 10.7 MHz                       |

### AM tuner section

|                       |  |
|-----------------------|--|
| Tuning range          | 530 - 1,710 kHz                                  |
| North American model: | (with the interval set at 10 kHz)                |
| AM:                   | 531 - 1,710 kHz (with the interval set at 9 kHz) |
| European model:       | 522 - 1,611 kHz (with the interval set at 9 kHz) |
| MW:                   | 144 - 288 kHz (with the interval set at 3 kHz)   |
| LW:                   |  |

## Specifications (continued)

|                        |   |
|------------------------|---|
| Other models:          |   |
| MW:                    | 531 – 1,602 kHz<br>(with the interval set at 9 kHz)<br>530 – 1,710 kHz<br>(with the interval set at 10 kHz) |
| SW:                    | 5.95 – 17.90 MHz  |
| Antenna                | AM loop antenna<br>External antenna terminals   |
| Intermediate frequency | 450 kHz   |

## Speaker

|                   |                         |
|-------------------|-------------------------|
| <b>SS-MD515</b>   |                         |
| Speaker system    | 2-way, bass-reflex type |
| Speaker units     |                         |
| Woofers:          | 15 cm dia., cone type   |
| Tweeters:         | 2.5 cm dia., cone type  |
| Nominal impedance | 6 ohms                  |

## General

|                       |  |
|-----------------------|--|
| Power requirements    |  |
| North American model: | 120 V AC, 60 Hz  |
| European model:       | 220 – 230 V AC, 50/60 Hz   |
| Other models:         | 110 – 120 V or 220 – 240 V AC, 50/60 Hz adjustable with the voltage selector |

Power consumption 85 watts

## Dimensions

|                                |  |
|--------------------------------|--|
| Amplifier/Tuner/MD/CD section: |  |
| (With the controller attached) | Approx. 215 × 290 × 400 mm (w/h/d) incl. projecting parts and controls |
| (With the controller detached) | Approx. 215 × 290 × 390 mm (w/h/d) incl. projecting parts and controls |

|           |  |
|-----------|--|
| Speakers: | Approx. 190 × 350 × 275 mm (w/h/d) incl. projecting parts and controls |
|-----------|--|

## Mass

|                                |                                |
|--------------------------------|--------------------------------|
| Amplifier/Tuner/MD/CD section: | Approx. 9.5 kg                 |
| Speakers:                      | Approx. 3.6 kg net per speaker |

## Supplied accessories:

- AM loop antenna (1)
- Detachable controller RM-MD515 (1)
- Terminal protector (1)
- MD cartridge (1)
- AA (R6) batteries (2)
- FM lead antenna (1)
- Speaker cords (2)

## Index

### A

- Adjusting
  - the sound 54
  - the volume 13
- Analog recording 33
- Antennas 4, 11
- Auto Cut 44
- Automatic Source Selection 17

### B

- Batteries 9

### C

- CD player 20
- CD-MD Synchro Recording 13
- CD-TEXT 27
- Clock setting 5
- Combine Function 51
- Connecting. *See* Hooking up

### D

- Daily Timer 59
- DBFB 54
- Detachable controller 9
- Digital recording 33
- Dimmer 13
- Disc Memo Copy 15
- Display 23, 32
- Divide Function 50

### E, F

- Editing 45
- Erase Function 47
- Erasing
  - a portion of a track 49
  - a single track 47
  - all tracks on an MD 48

### G

- GROOVE 54

### H, I, J, K

- Hit Parade 39
- Hooking up
  - optional components 10
  - the antennas 4, 11
  - the power 5
  - the system 4

### L

- Labeling
  - a CD 25
  - an MD 46
  - a preset station 55
- Loop 24

### M

- Marking track numbers 43
- MD cartridge 5, 63
- Messages 67
- Move Function 49

### N, O

- Name Function 46
- Normal Play 12, 15

### P, Q

- Playing
  - a CD 12
  - an MD 15
  - a preset radio station 17
  - tracks in random order (Shuffle Play) 20, 29
  - tracks in the desired order (Program Play) 21, 30
  - tracks repeatedly (Repeat Play) 20, 29
- Preset equalizer menu 54
- Preset tuning 17
- Presetting radio stations 6
- Program Play 21, 30
- Protecting recordings 33
- PTY 57

### R

- Radio stations
  - presetting 6
  - tuning in 17
- RDS 56
- Rec It 40
- Recording
  - a CD 13
  - a radio program 18
  - on an MD 41
  - timer recording 60
- Recording methods 34
- Repeat Play 20, 29

### S

- Saving recordings 33
- Seamless Recording 36
- Serial copy management system 64
- Setting the time 5
- Shuffle Play 20, 29
- Sleep Timer 58
- Smart Space 44
- Sound adjustment 54
- Speakers 4
- Station Name 55
- System limitations 64

### T

- 3CD-3MD Synchro Recording 35
- Time Machine Recording 42
- Timer
  - falling asleep to music 58
  - timer recording 60
  - waking up to music 59
- Track marking 43
- Track numbers 43
- Troubleshooting 65
- Tuner 6, 17

### U, V, W, X, Y, Z

- Undoing the last edit 53